

Course 2: Basic Technologies

Part III: Synchrotron Sources / FEL

Synchrotron Radiation



Facts and figures

- Ring accelerator for electrons and positrons
- Length: 2304 metres
- Commissioning: 1978
- 1978-1986: particle physics
- 1987-2007: pre-accelerator for HERA and X-ray radiation source
- Since 2009: most brilliant storage-ring-based X-ray source in the world
- Start of user operation: 2009
- 14 experimental stations with up to 30 instruments

relativistic electrons

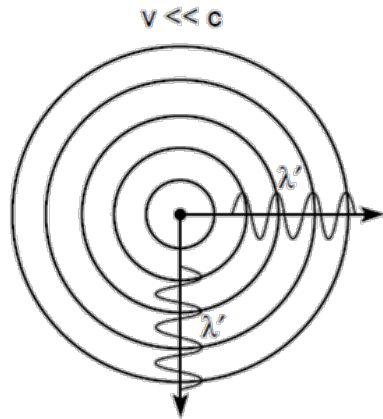

Frame moving with electron

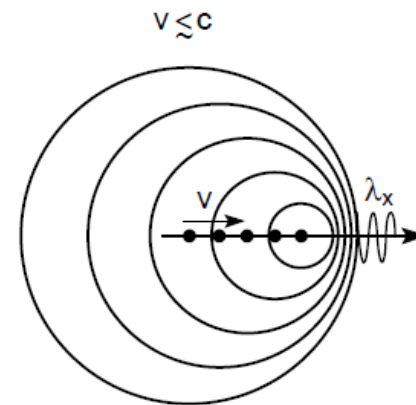

Laboratory frame of reference

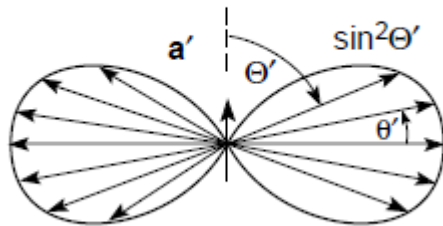

$$\lambda = \lambda' \left(1 - \frac{v}{c} \cos \theta\right)$$

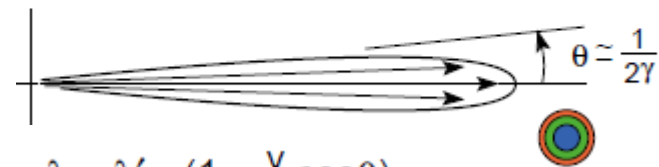

$$\lambda = \lambda' \gamma \left(1 - \frac{v}{c} \cos \theta\right)$$

$$\gamma = \frac{1}{\sqrt{1 - \frac{v^2}{c^2}}}$$

$$\tan \theta = \frac{\sin \theta'}{\gamma (\beta + \cos \theta')}$$

Relativistic Electrons Radiate in a Narrow Forward Cone

Dipole radiation

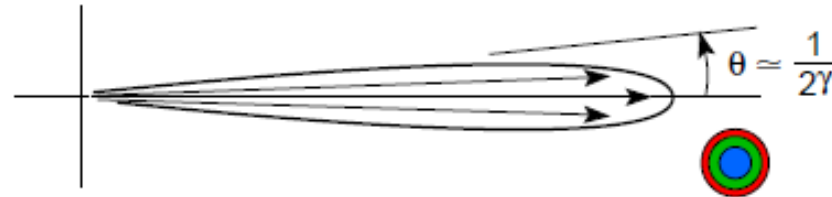
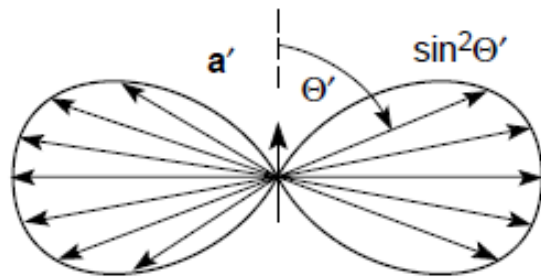

Frame of reference moving with electrons

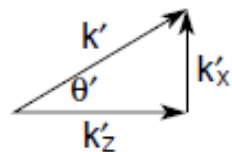

$$k' = 2\pi/\lambda'$$

Lorentz transformation

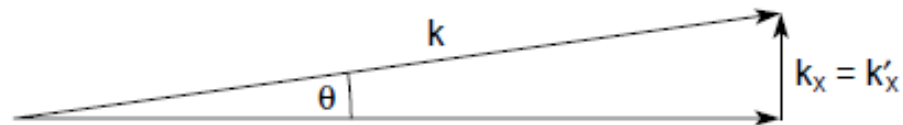

$$k_z = 2\gamma k'_z \text{ (Relativistic Doppler shift)}$$

$$\theta \approx \frac{k_x}{k_z} \approx \frac{k'_x}{2\gamma k'_z} = \frac{\tan\theta'}{2\gamma} \approx \frac{1}{2\gamma}$$

Three types of radiation

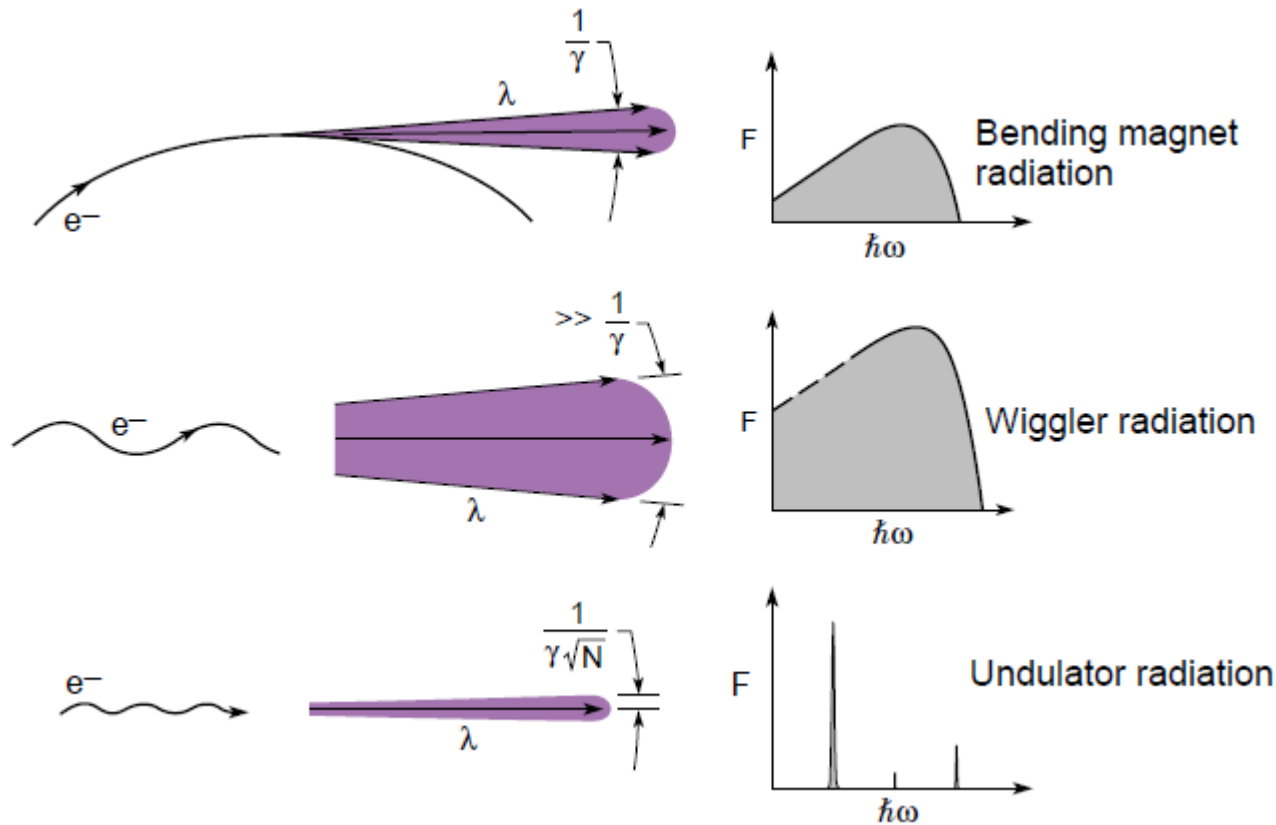

1. Bending magnet radiation (... „old style“)

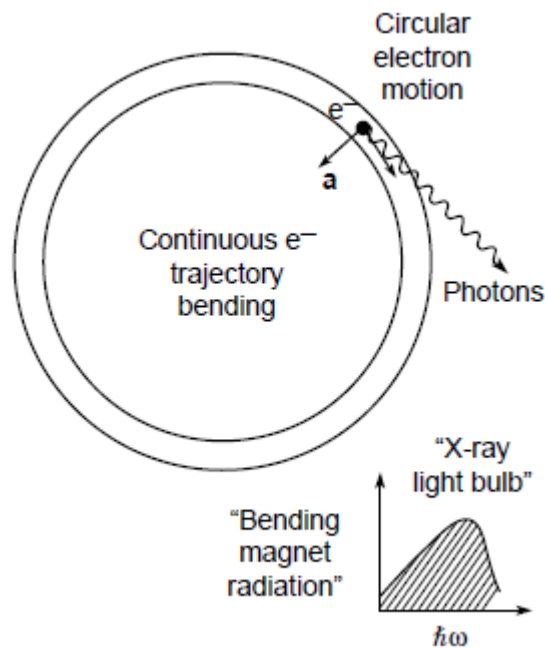

$$R = \frac{\gamma m v}{e B} \simeq \frac{\gamma m c}{e B}$$

The Lorentz force for a relativistic electron in a constant magnetic field is

$$\mathbf{F} = \frac{d\mathbf{p}}{dt} = -e\mathbf{v} \times \mathbf{B}$$

where $\mathbf{p} = \gamma m \mathbf{v}$. In a fixed magnetic field the rate of change of electron energy is

$$\frac{dE_e}{dt} = \mathbf{v} \cdot \mathbf{F} = \underbrace{-e\mathbf{v} \cdot (\mathbf{v} \times \mathbf{B})}_{=0}$$

thus with $E_e = \gamma m c^2$

$$\frac{dE_e}{dt} = \frac{d}{dt}(\gamma m c^2) = 0$$

$$\therefore \gamma = \text{constant}$$

and the force equation becomes

$$\frac{d\mathbf{p}}{dt} = \gamma m \frac{d\mathbf{v}}{dt} = -e\mathbf{v} \times \mathbf{B}$$

$$\gamma m \left(-\frac{v^2}{R} \right) = -e v B$$

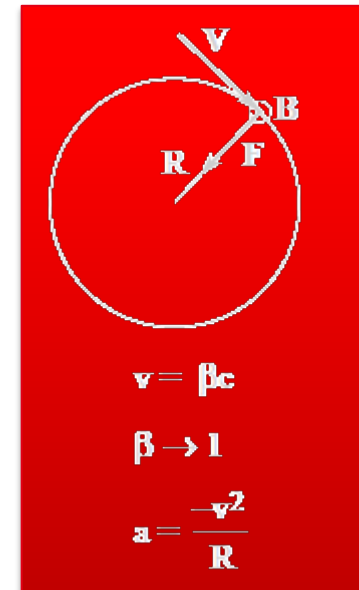

Bending Magnet Radiation

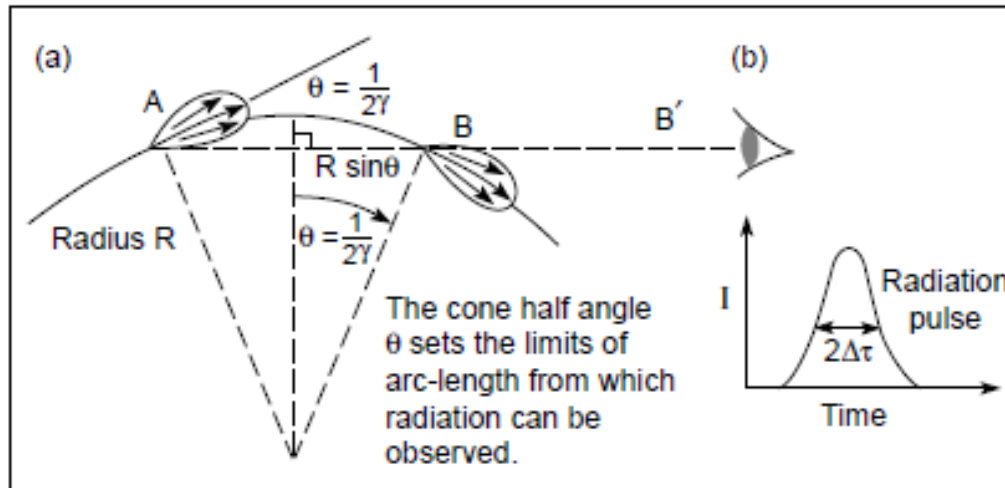

$$2\Delta\tau = \tau_e - \tau_r$$

$$2\Delta\tau = \frac{\text{arc length}}{v} - \frac{\text{radiation path}}{c}$$

$$2\Delta\tau \simeq \frac{R \cdot 2\theta}{v} - \frac{2R \sin\theta}{c}$$

With $\theta \simeq 1/2\gamma$, $\sin\theta \simeq \theta$

$$2\Delta\tau \simeq \frac{R}{\gamma v} - \frac{R}{\gamma c} = \frac{R}{\gamma} \left(\frac{1}{v} - \frac{1}{c} \right)$$

With $v = \beta c$

$$2\Delta\tau \simeq \frac{R}{\gamma\beta c} (1 - \beta) \quad \text{but} \quad (1 - \beta) \simeq \frac{1}{2\gamma^2} \quad \text{and} \quad R \simeq \frac{\gamma mc}{eB}$$

$$2\Delta\tau = \frac{m}{2eB\gamma^2}$$

Bending magnet radiation revisited

From Heisenberg's Uncertainty Principle for rms pulse duration and photon energy

$$\Delta E \cdot \Delta \tau \geq \hbar/2$$

thus

$$\Delta E \geq \frac{\hbar}{2\Delta \tau}$$

$$\Delta E \geq \frac{\hbar}{m/2eB\gamma^2}$$

Thus the single-sided rms photon energy width (uncertainty) is

$$\Delta E \geq \frac{2e\hbar B\gamma^2}{m}$$

A more detailed description of bending magnet radius finds the critical photon energy

$$E_c = \hbar\omega_c = \frac{3e\hbar B\gamma^2}{2m}$$

In practical units the critical photon energy is

$$E_c(\text{keV}) = 0.6650 E_e^2(\text{GeV}) B(\text{T})$$

bending magnet - summary

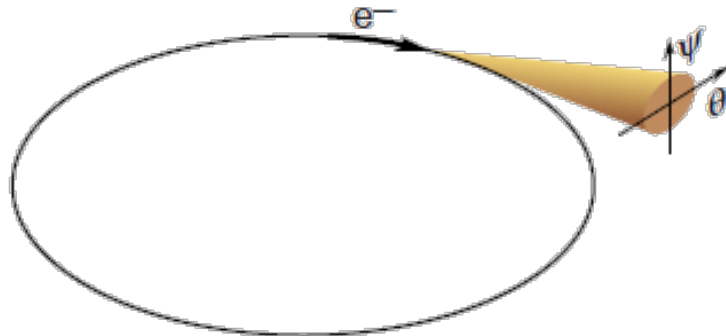

$$E_c = \hbar\omega_c = \frac{3e\hbar B\gamma^2}{2m} \quad (5.7a)$$

$$E_c(\text{keV}) = 0.6650 E_e^2(\text{GeV}) B(\text{T}) \quad (5.7b)$$

$$\frac{d^2 F_B}{d\theta d\omega/\omega} = 2.46 \times 10^{13} E_e(\text{GeV}) I(\text{A}) G_1(E/E_e) \frac{\text{photons/s}}{\text{mrad} \cdot (0.1\% \text{BW})} \quad (5.8)$$

Advantages:

- covers broad spectral range
- least expensive
- most accessible

Disadvantages:

- limited coverage of hard x-rays
- not as bright as undulator

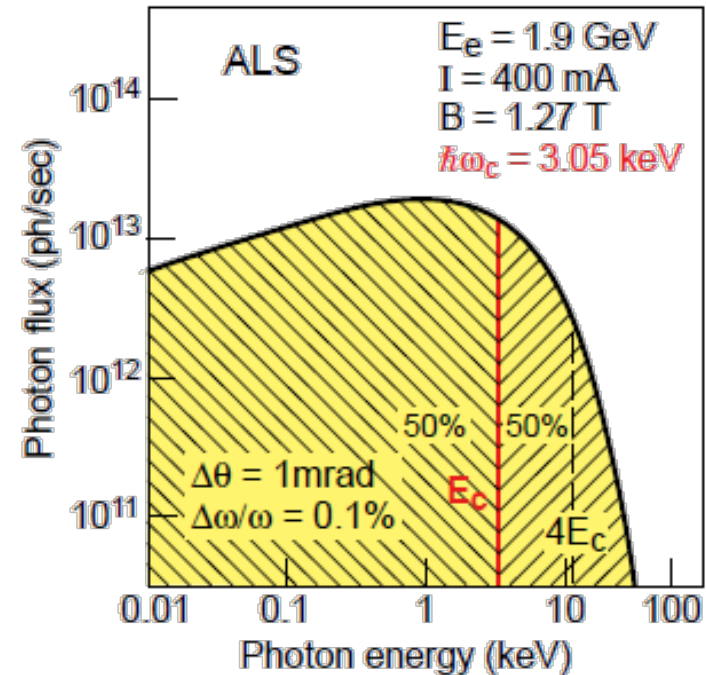

Undulator

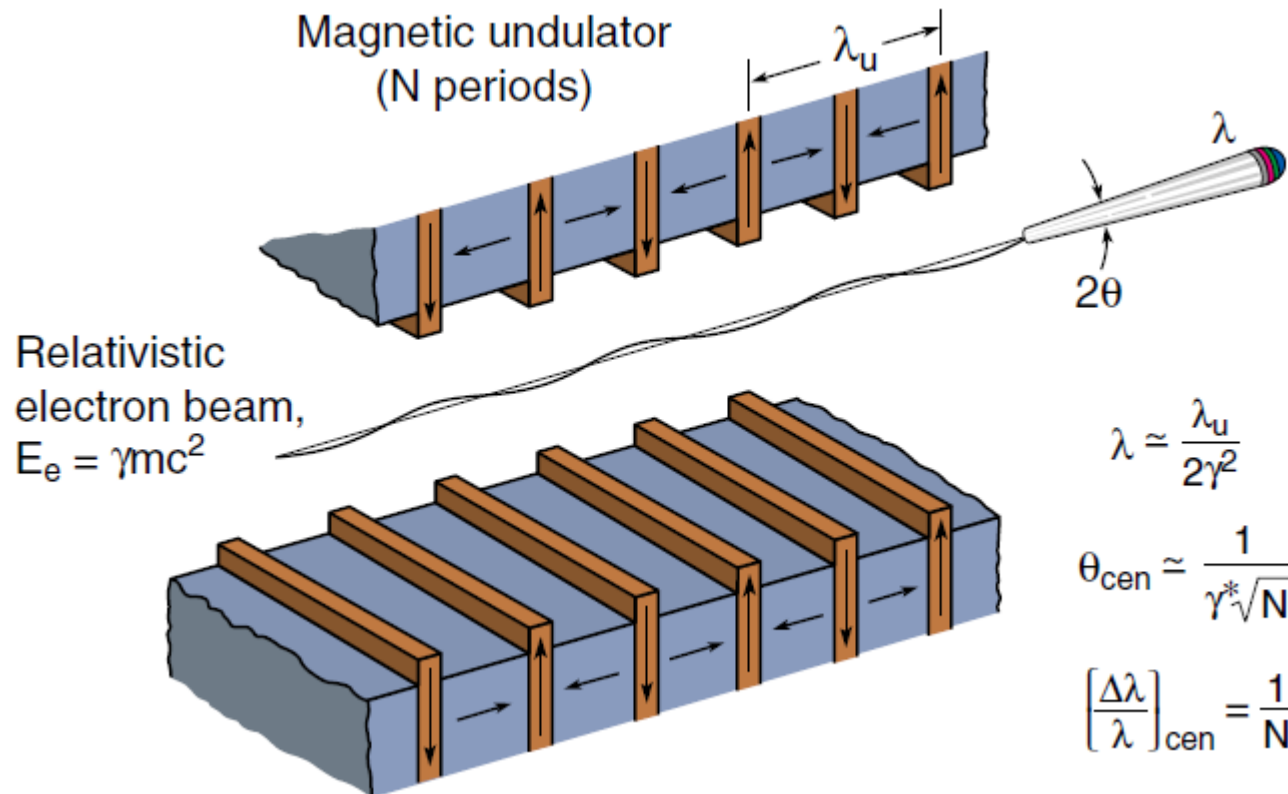

undulator radiation

Laboratory Frame
of Reference

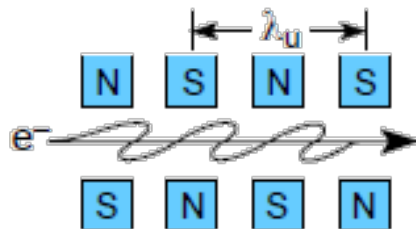

$$E = \gamma mc^2$$

$$\gamma = \frac{1}{\sqrt{1 - \frac{v^2}{c^2}}}$$

$N = \#$ periods

Frame of moving e^-

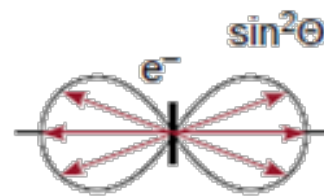

e^- radiates at the
Lorentz contracted
wavelength:

$$\lambda' = \frac{\lambda_u}{\gamma}$$

Bandwidth:

$$\frac{\lambda'}{\Delta\lambda'} = N$$

Frame of observer

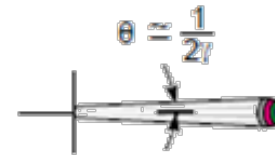

Doppler shortened
wavelength on axis:

$$\lambda = \lambda' \gamma (1 - \beta \cos \theta)$$

$$\lambda = \frac{\lambda_u}{2\gamma^2} (1 + \gamma^2 \theta^2)$$

Accounting for transverse
motion due to the periodic
magnetic field:

$$\lambda = \frac{\lambda_u}{2\gamma^2} \left(1 + \frac{K^2}{2} + \gamma^2 \theta^2\right)$$

where $K = eB_0 \lambda_u / 2\pi mc$

where does the $\lambda = \lambda_u/2\gamma^2$ come from?

The electron “sees” a Lorentz contracted period

$$\lambda' = \frac{\lambda_u}{\gamma}$$

and emits radiation in its frame of reference at frequency

$$f' = \frac{c}{\lambda'} = \frac{c\gamma}{\lambda_u}$$

Observed in the laboratory frame of reference, this radiation is Doppler shifted to a frequency

$$f = \frac{f'}{\gamma(1 - \beta \cos \theta)} = \frac{c}{\lambda_u(1 - \beta \cos \theta)}$$

On-axis ($\theta = 0$) the observed frequency is

$$f = \frac{c}{\lambda_u(1 - \beta)}$$

$$f = \frac{c}{\lambda_u(1 - \beta)}$$

By definition $\gamma = \frac{1}{\sqrt{1 - \beta^2}}$; $\gamma^2 = \frac{1}{(1 - \beta)(1 + \beta)} \approx \frac{1}{2(1 - \beta)}$

thus

$$f = \frac{2\gamma^2 c}{\lambda_u}$$

and the observed wavelength is

$$\lambda = \frac{c}{f} = \frac{\lambda_u}{2\gamma^2}$$

With electrons executing N oscillations as they traverse the periodic magnet structure, and thus radiating a wavetrain of N cycles, it is of interest to know what angular cone contains radiation of relative spectral bandwidth

$$\frac{\Delta\lambda}{\lambda} = \frac{1}{N} \quad (5.14)$$

Write the undulator equation twice, once for on-axis radiation ($\theta = 0$) and once for shifted radiation off-axis at angle θ :

$$\lambda_0 + \Delta\lambda = \frac{\lambda_u}{2\gamma^2} (1 + \gamma^2\theta^2)$$

$$\lambda_0 = \frac{\lambda_u}{2\gamma^2}$$

divide and simplify to

$$\frac{\Delta\lambda}{\lambda} \simeq \gamma^2\theta^2 \quad (5.13)$$

Combining the two equations (5.13 and 5.14)

defines θ_{cen} : $\gamma^2\theta_{\text{cen}}^2 \equiv \frac{1}{N}$, which gives $\theta_{\text{cen}} \simeq \frac{1}{\gamma\sqrt{N}}$ (5.15)

This is the half-angle of the “central radiation cone”, defined as containing radiation of $\Delta\lambda/\lambda = 1/N$.

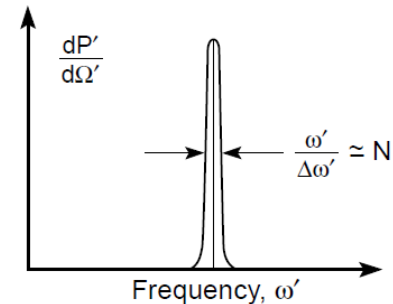

Execution of N electron oscillations produces a transform-limited spectral bandwidth, $\Delta\omega'/\omega' = 1/N$.

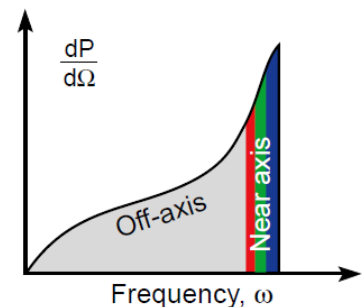

The Doppler frequency shift has a strong angle dependence, leading to lower photon energies off-axis.

radiation power of an undulator

$$\lambda_x = \frac{\lambda_u}{2\gamma^2} \left(1 + \frac{K^2}{2} + \gamma^2 \theta^2 \right)$$

$$\bar{P}_{\text{cen}} = \frac{\pi e \gamma^2 I}{\epsilon_0 \lambda_u} \frac{K^2}{\left(1 + \frac{K^2}{2} \right)^2} f(K)$$

$$\theta_{\text{cen}} = \frac{1}{\gamma^* \sqrt{N}}$$

$$\left(\frac{\Delta\lambda}{\lambda} \right)_{\text{cen}} = \frac{1}{N}$$

$$K = \frac{e B_0 \lambda_u}{2\pi m_0 c}$$

$$\gamma^* = \gamma / \sqrt{1 + \frac{K^2}{2}}$$

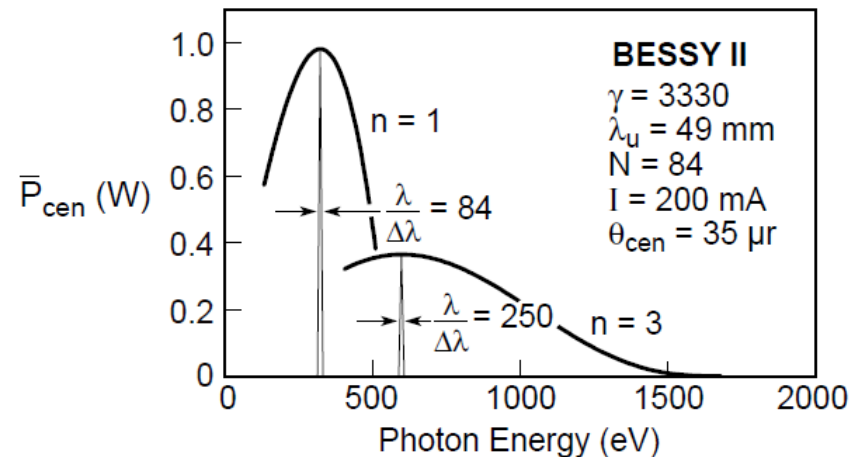
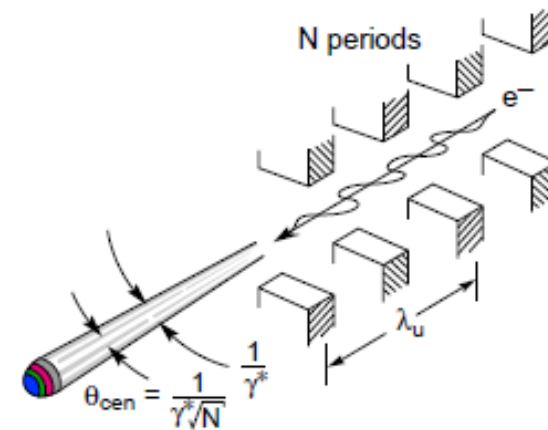

Magnetic fields in the periodic undulator cause the electrons to oscillate and thus radiate. These magnetic fields also slow the electrons axial (z) velocity somewhat, reducing both the Lorentz contraction and the Doppler shift, so that the observed radiation wavelength is not quite so short. The force equation for an electron is

$$\frac{d\mathbf{p}}{dt} = -e(\mathbf{E} + \mathbf{v} \times \mathbf{B})$$

where $\mathbf{p} = \gamma m \mathbf{v}$ is the momentum. The radiated fields are relatively weak so that

$$\frac{d\mathbf{p}}{dt} \approx -e(\mathbf{v} \times \mathbf{B})$$

Taking to first order $v \approx v_z$, motion in the x -direction is

$$m\gamma \frac{dv_x}{dt} = +ev_z B_y$$

$$m\gamma \frac{dv_x}{dt} = e \frac{dz}{dt} \cdot B_0 \cos\left(\frac{2\pi z}{\lambda_u}\right) \quad (0 \leq z \leq N\lambda_u)$$

$$m\gamma dv_x = e dz B_0 \cos\left(\frac{2\pi z}{\lambda_u}\right)$$

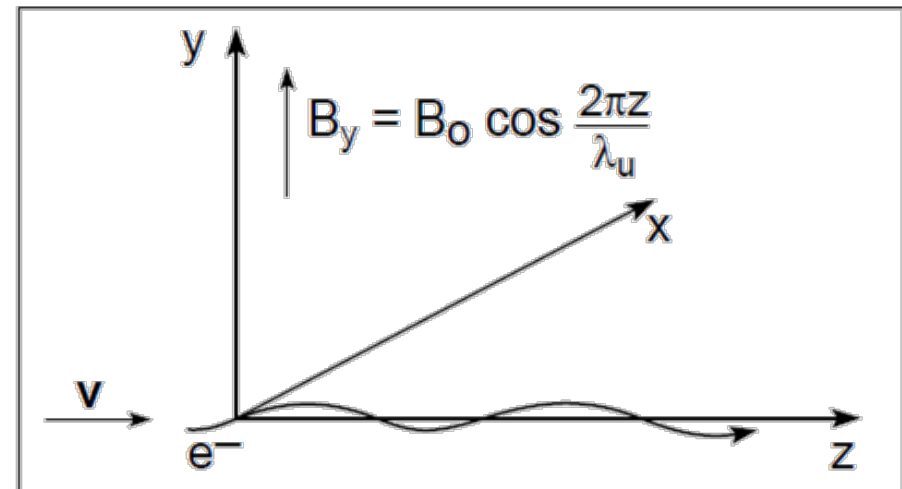

$$m\gamma dv_x = e dz B_0 \cos\left(\frac{2\pi z}{\lambda_u}\right)$$

integrating both sides

$$m\gamma v_x = e B_0 \frac{\lambda_u}{2\pi} \int \cos\left(\frac{2\pi z}{\lambda_u}\right) \cdot d\left(\frac{2\pi z}{\lambda_u}\right)$$

$$m\gamma v_x = \frac{e B_0 \lambda_u}{2\pi} \sin\left(\frac{2\pi z}{\lambda_u}\right)$$

$$v_x = \frac{Kc}{\gamma} \sin\left(\frac{2\pi z}{\lambda_u}\right)$$

$$K \equiv \frac{e B_0 \lambda_u}{2\pi m c} = 0.9337 B_0(\text{T}) \lambda_u(\text{cm})$$

is the non-dimensional “magnetic deflection parameter.”
The “deflection angle”, θ , is

$$\theta = \frac{v_x}{v_z} \approx \frac{v_x}{c} = \frac{K}{\gamma} \sin k_u z$$

calculating the radiation power of the central cone

x, z, t laboratory frame of reference

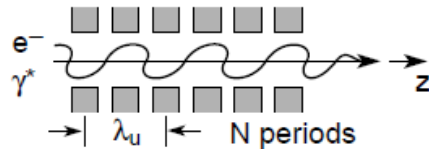

Lorentz transformation

x', z', t' frame of reference moving with the average velocity of the electron

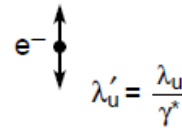

x', z', t' motion
 $a'(t')$ acceleration

$$\bar{P}_{\text{cen}} = \frac{\pi e \gamma^2 I}{\epsilon_0 \lambda_u} \frac{K^2}{(1 + \frac{K^2}{2})^2} f(K)$$

Determine x, z, t motion:

$$\frac{d\mathbf{p}}{dt} = -e (\mathbf{E} + \mathbf{v} \times \mathbf{B})$$

$$m\gamma \frac{dv_x}{dt} = e \frac{dz}{dt} B_0 \cos \frac{2\pi z}{\lambda_u}$$

$$v_x(t); a_x(t) = \dots$$

$$v_z(t); a_z(t) = \dots$$

Dipole radiation:

$$\frac{dP'}{d\Omega'} = \frac{e^2 a'^2 \sin^2 \Theta'}{16\pi^2 \epsilon_0 c^3}$$

$$\frac{dP'}{d\Omega'} = \frac{e^2 c \gamma^2}{4\epsilon_0 \lambda_u^2} \frac{K^2}{(1 + K^2/2)^2} (1 - \sin^2 \theta' \cos^2 \phi') \cos^2 \omega'_u t'$$

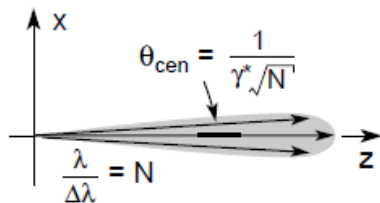

Lorentz transformation

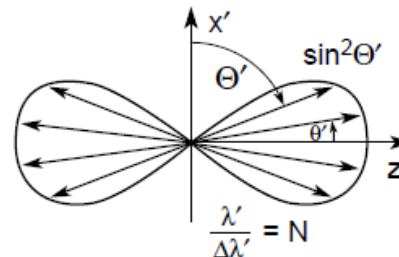

bandwith of the undulator radiation

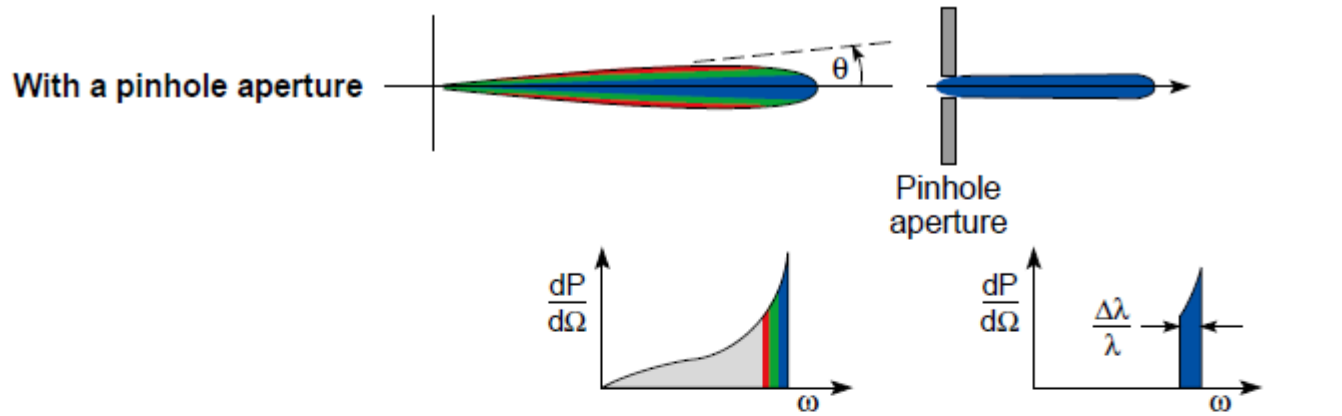

The Narrow (1/N) Spectral Bandwidth of Undulator Radiation Can be Recovered in Two Ways

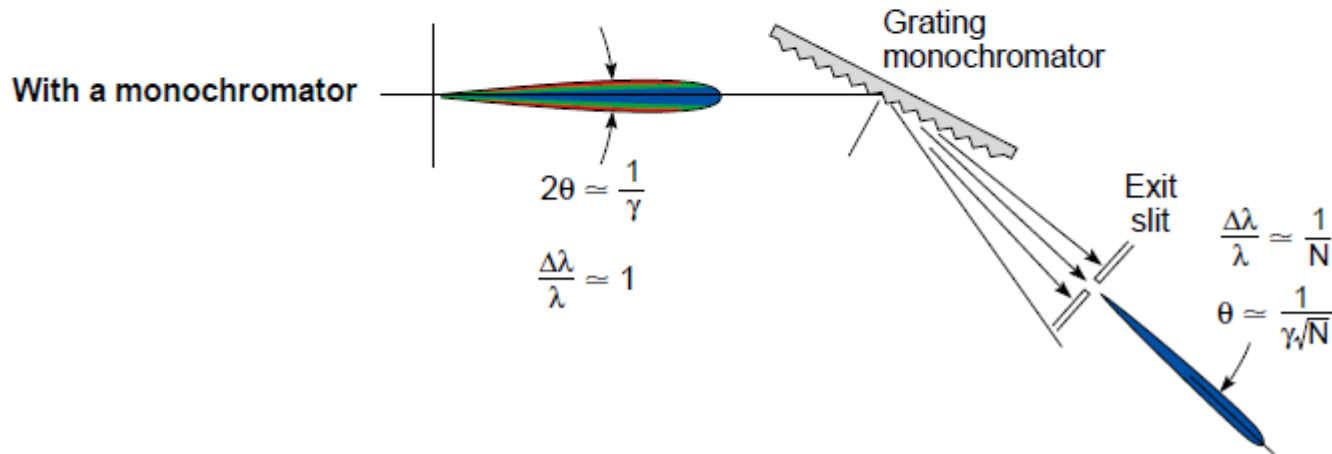

Polarisation properties

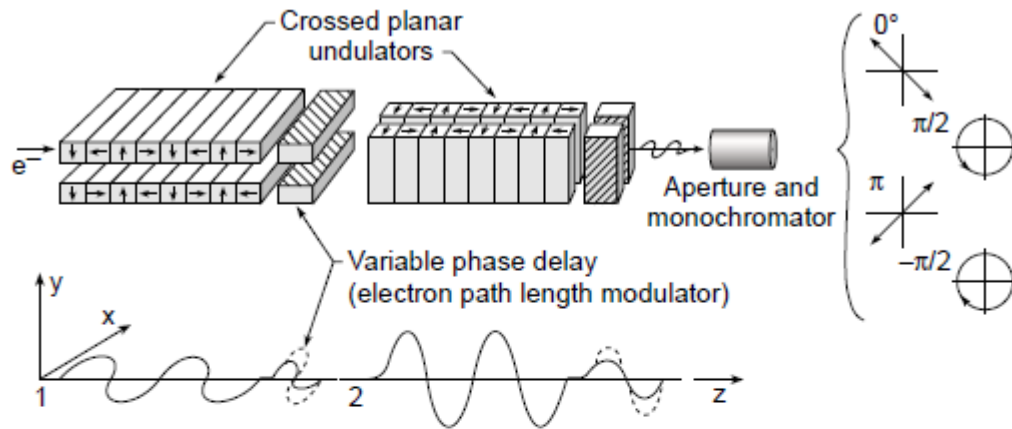

(Courtesy of Kwang-Je Kim)

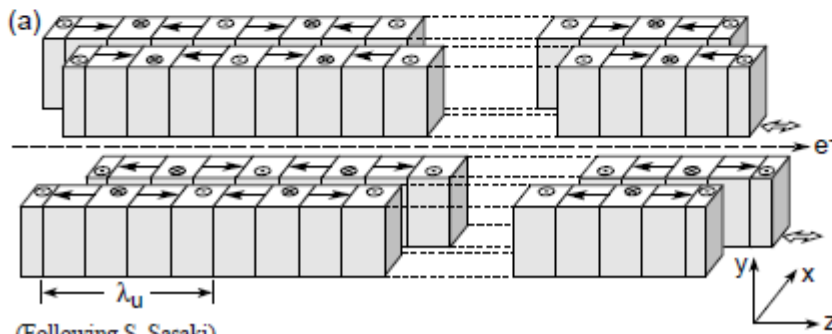
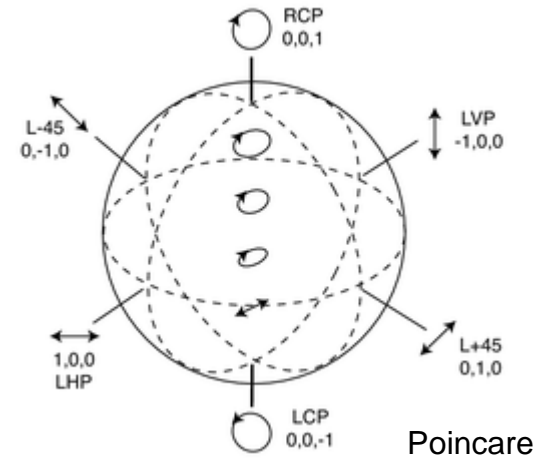

(Following S. Sasaki)

PETRA III

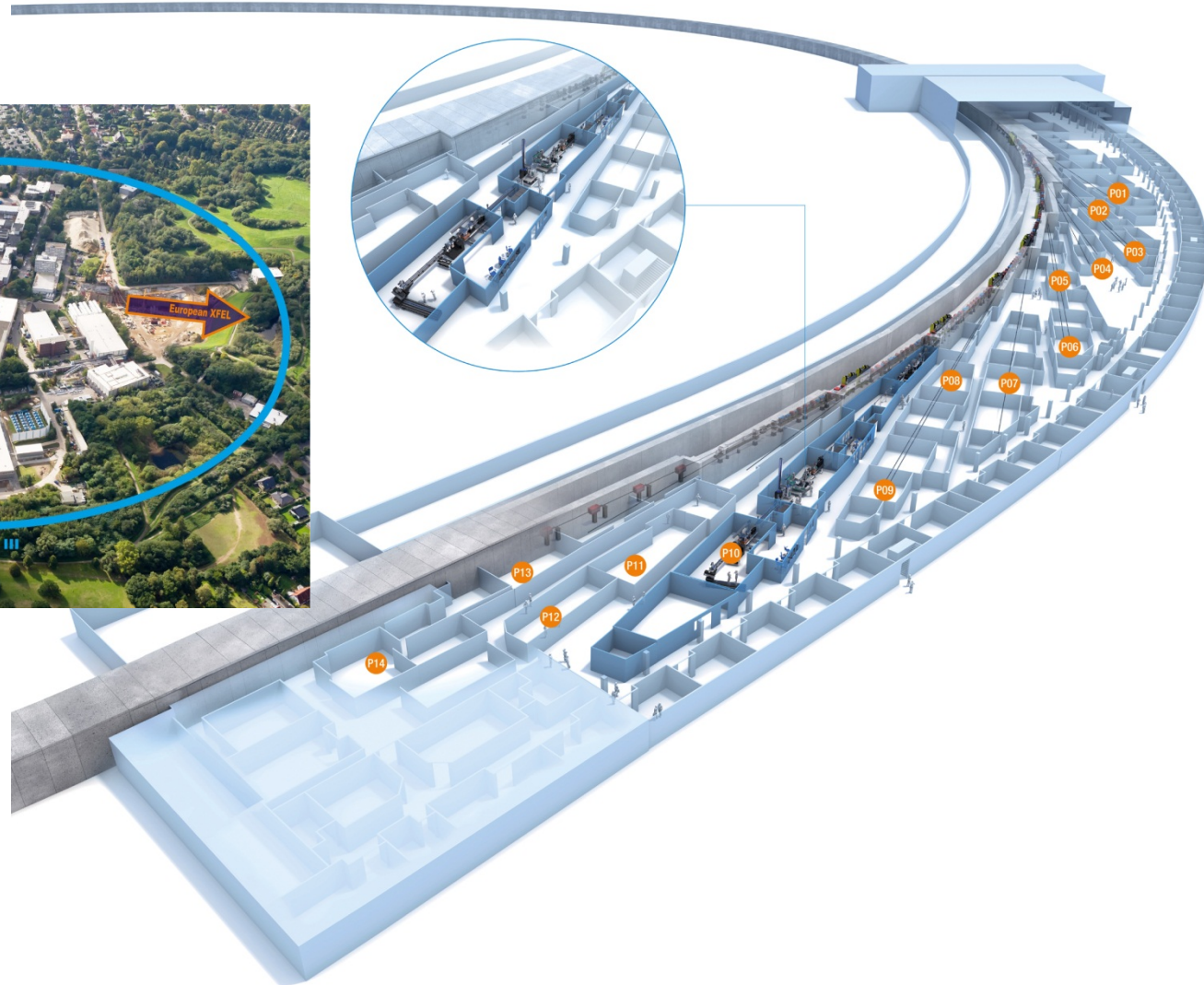
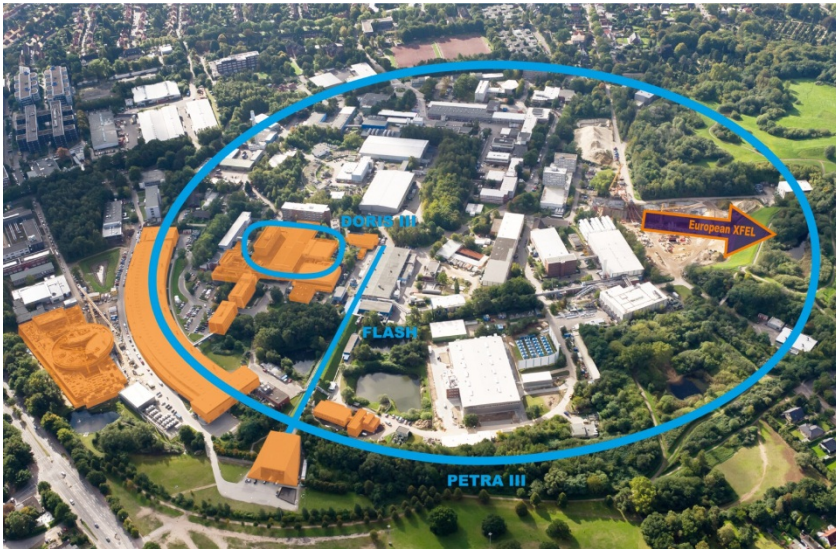

Benefits of synchrotron radiation

Spectrum (tunability, bandwidth...)

Prediction

Polarisation (very clean)

time structure (electron bunches)

UHV compatible

Intensity

High optical power with very good focusability

Comparison

Bending magnet radiation

Broad spectrum

Good photon flux

No heat load

Less expensive

Easy access

Wiggler radiation

Higher photon energies

More photon flux

Expensive magnet structure

Expensive cooled optics

Less access

Undulator radiation

Brighter radiation

Smaller spot size

Partial coherence

Expensive

Less access

Further information

Prof. David Attwood

Soft X-Ray and Extreme Ultraviolet Radiation,
Cambridge University Press, 1999

<http://ast.coe.berkeley.edu/srms/>

Synchrotron radiation sources

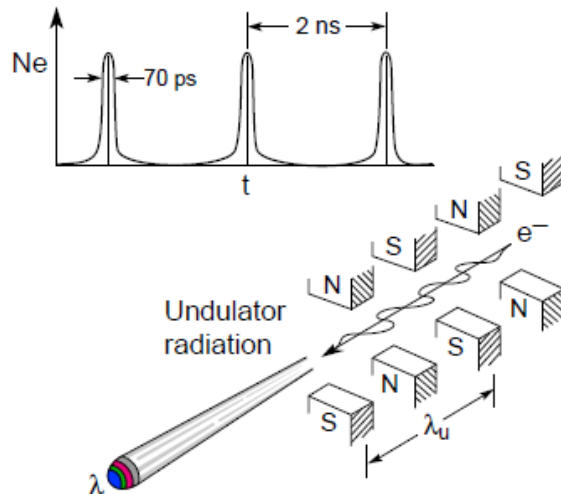
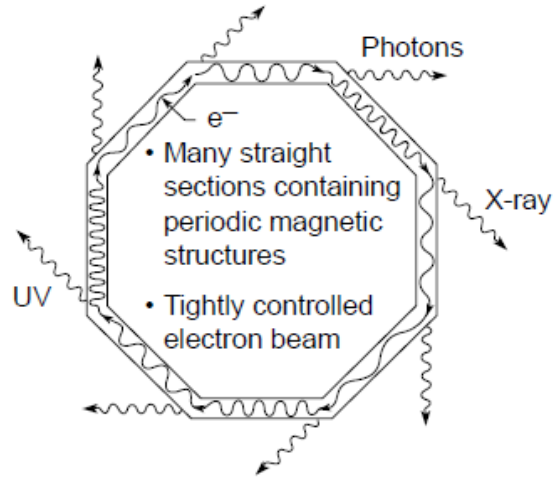

Bending Magnet:

$$\hbar\omega_c = \frac{3e\hbar B\gamma^2}{2m}$$

Wiggler:

$$\hbar\omega_c = \frac{3e\hbar B\gamma^2}{2m}$$

$$n_c = \frac{3K}{4} \left(1 + \frac{K^2}{2}\right)$$

$$P_T = \frac{\pi e K^2 \gamma^2 I N}{3\epsilon_0 \lambda_u}$$

Undulator:

$$\lambda = \frac{\lambda_u}{2\gamma^2} \left(1 + \frac{K^2}{2} + \gamma^2\theta^2\right)$$

$$K = \frac{eB_0\lambda_u}{2\pi mc}$$

$$\theta_{\text{cen}} = \frac{1}{\gamma\sqrt{N}}$$

$$\left.\frac{\Delta\lambda}{\lambda}\right|_{\text{cen}} = \frac{1}{N}$$

$$\bar{P}_{\text{cen}} = \frac{\pi e \gamma^2 I}{\epsilon_0 \lambda_u} \frac{K^2}{\left(1 + \frac{K^2}{2}\right)^2} f(K)$$

For a particle moving at a velocity v with a total energy E

$$E = \gamma m_0 c^2$$

$$\text{with } \gamma = \frac{1}{\sqrt{1 - \frac{v^2}{c^2}}}$$

short reminder...

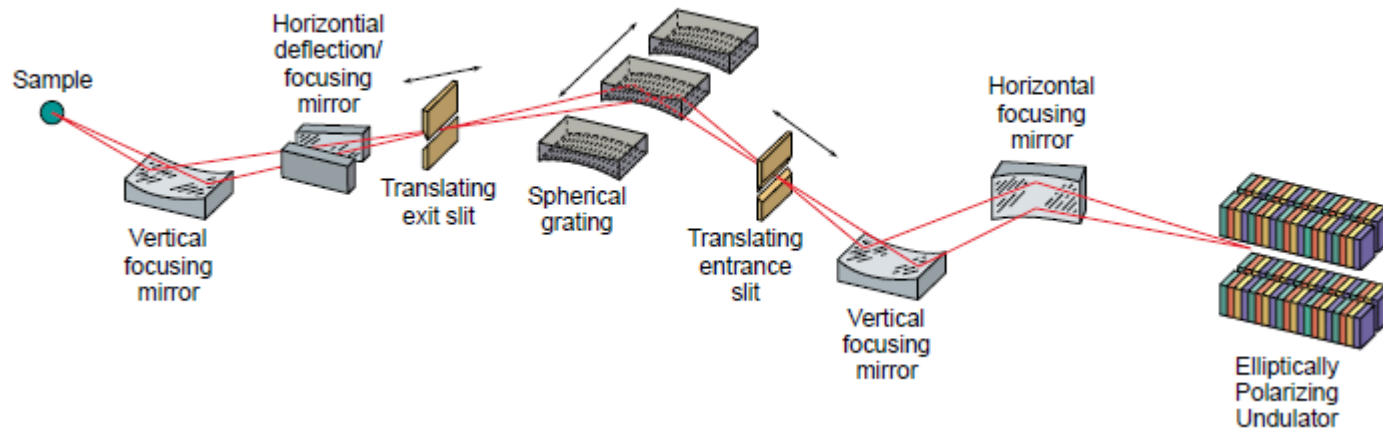

FEL – Free Electron Lasers

Some Free Electron Lasers



Undulator vs. FEL

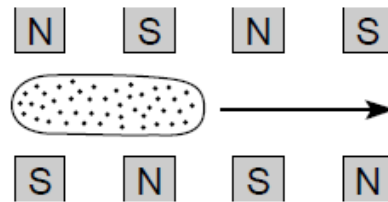

Undulator – uncorrelated electron positions, radiated fields uncorrelated, intensities add, limited coherence, power $\sim N$.

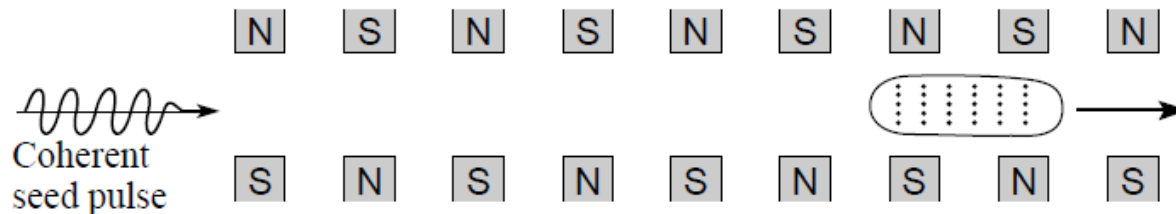

Free Electron Laser (FEL) – very long undulator, electrons are “microbunched” by their own radiated fields into strongly correlated waves of electrons, all radiated electric fields now add, spatially coherent, power $\sim N^2$

SR or ERL

Spontaneous Radiation

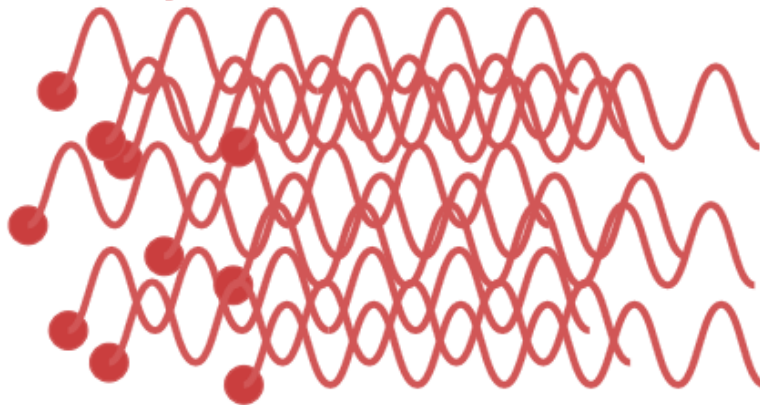

N-electrons
random distribution

$$E_{spt} \sim \sqrt{N} E_1$$

$$P_{spt} \sim N P_1$$

FEL: Free Electron Laser

Coherent Radiation

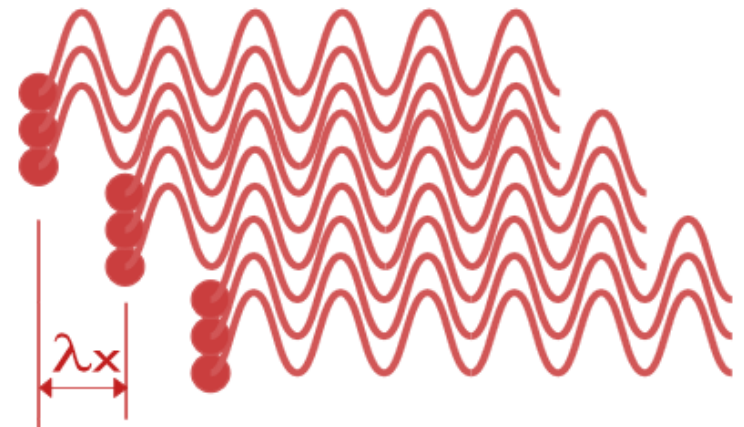

N-electrons
micro-bunched

$$E_{coherent} \sim N E_1$$

$$P_{coherent} \sim N^2 P_1$$

Flash Design layout

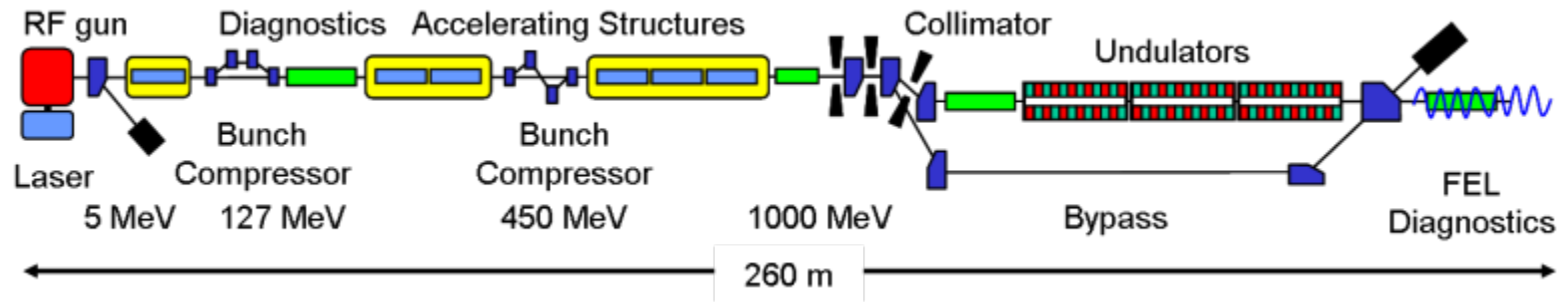

bunch compressor

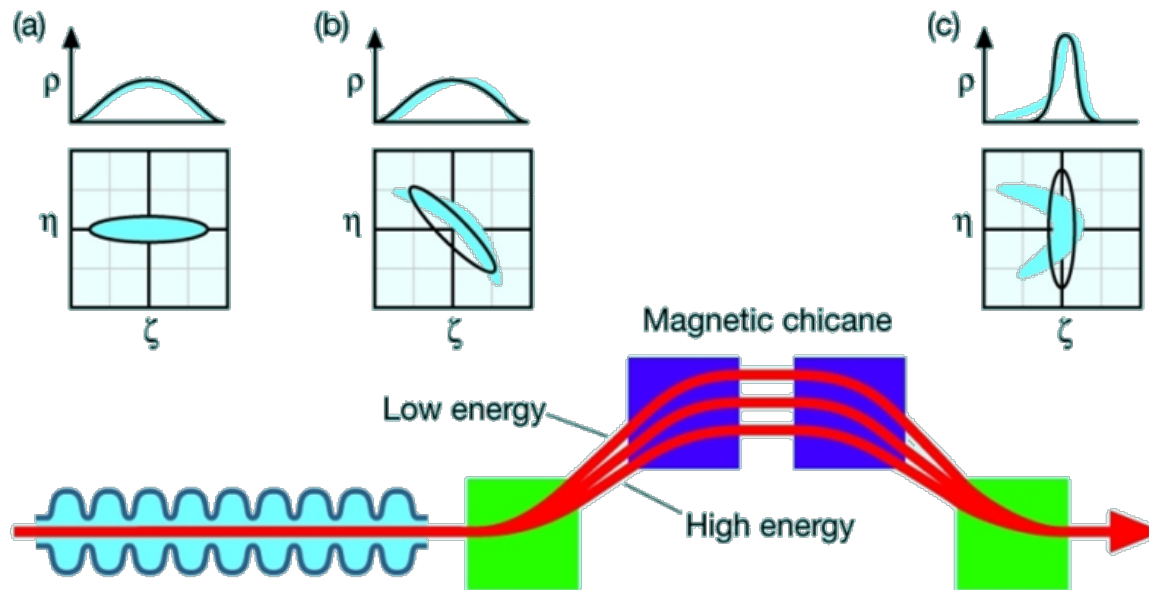

electron bunch in the undulator

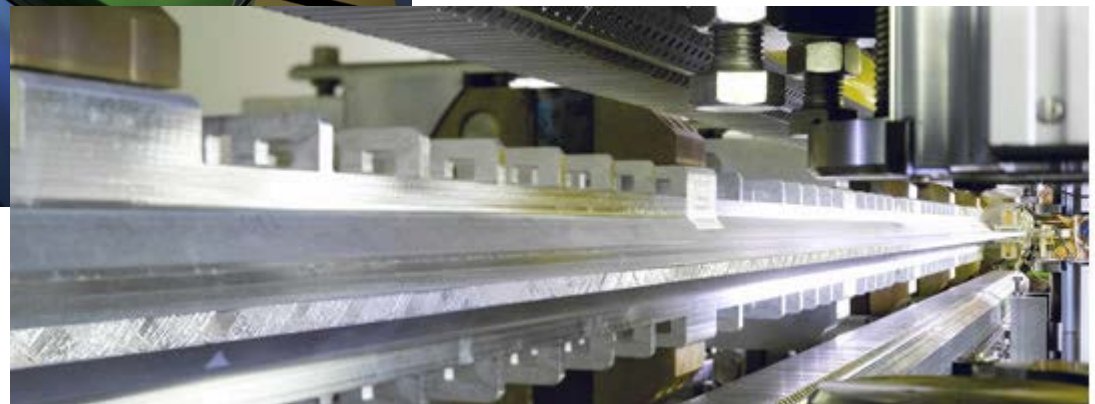
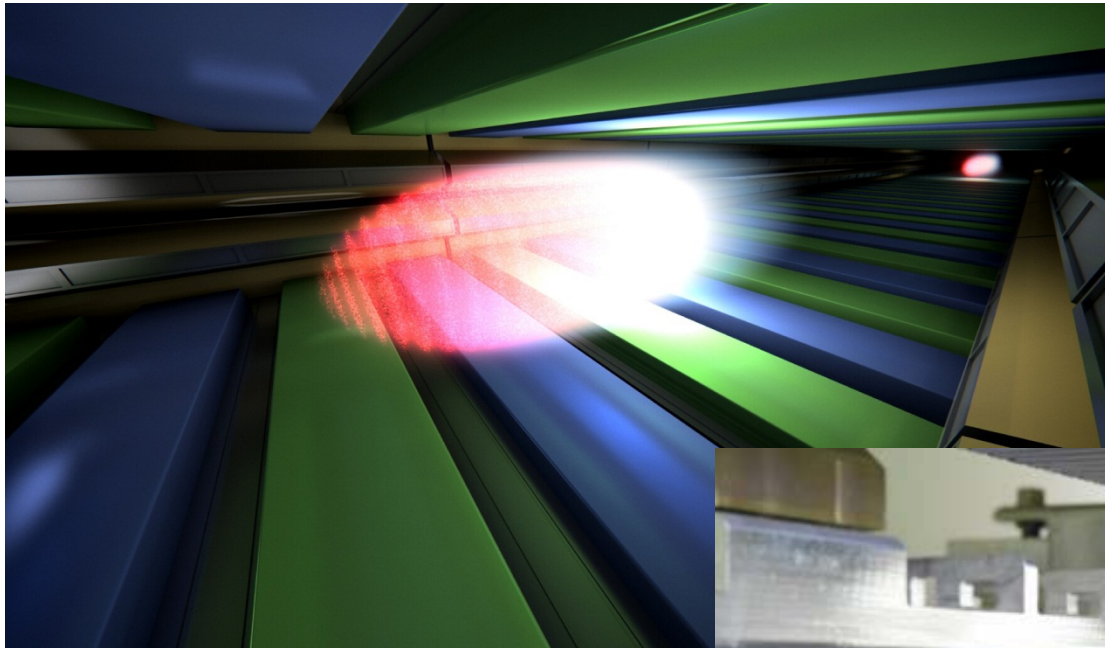

radiation power vs. undulator length

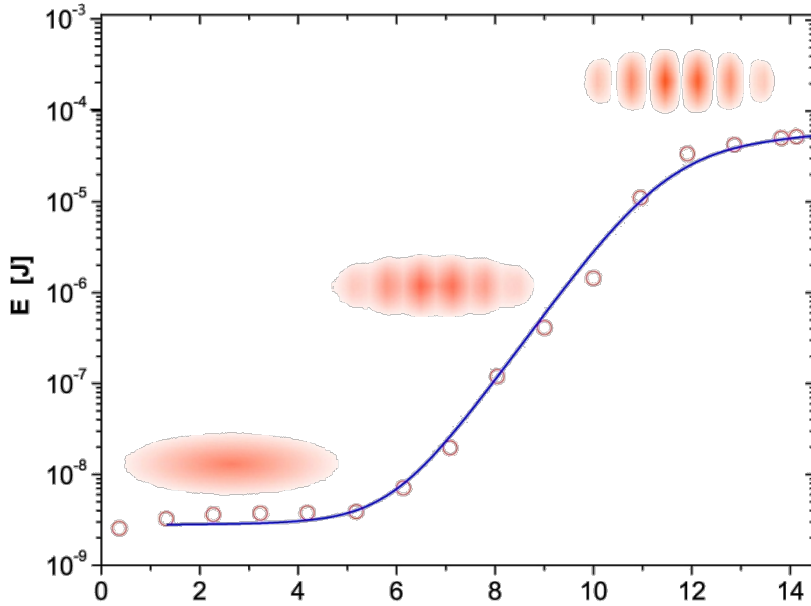

Power grows exponentially with undulator distance z . For a 1-D, mono-energetic beam

$$P \propto e^{\frac{z}{L_{G0}}} \quad \text{where } L_{G0} = \frac{\lambda_u}{4\sqrt{3}\pi\rho}$$

Pierce Parameter $\rho \sim \frac{\text{radiation power}}{\text{beam power}}$

peak current

$$\rho = \frac{1}{4\gamma_0} \left[\frac{I \lambda_u^2 K^2 [JJ]^2}{I_A \pi^2 \epsilon_x \beta_x} \right]$$

17 kA

beta function

emittance

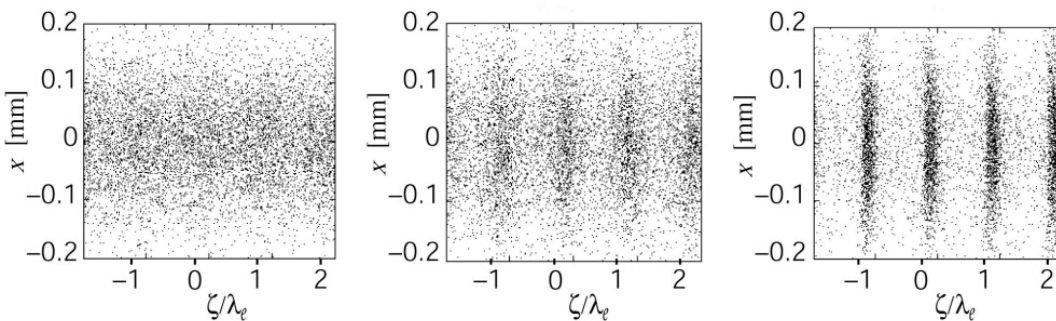

Pierce Parameter

Pierce parameter ρ says how many undulator periods must electrons travel in order to increase FEL power 2e-times

Important FEL parameters are expressed by ρ e.g.

$$\text{spectrum bandwidth} \approx \rho \quad P_{sat} \approx P_{beam} \cdot \rho$$

$$\text{Coherence time } \tau_c = \frac{1}{\omega\rho}$$

undulator radiation in a long undulator

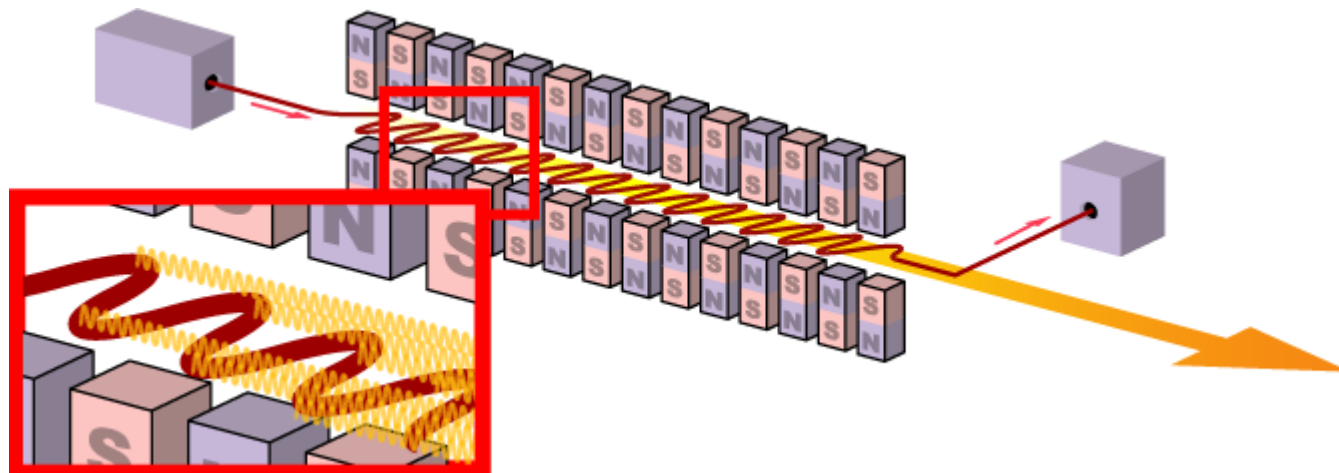

http://en.wikipedia.org/wiki/Free-electron_laser

SASE – Self Amplified Stimulated Emission

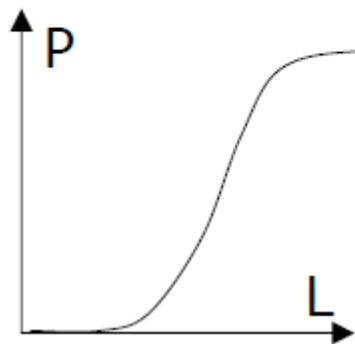
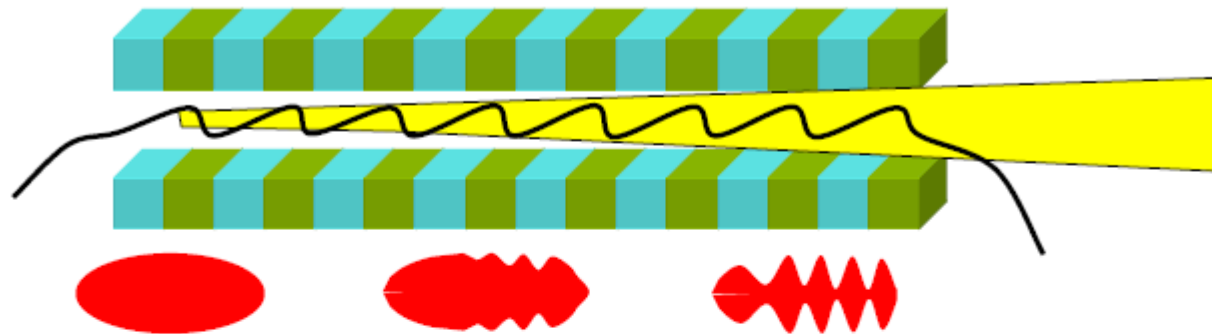

- From noise
- No mirrors (☹ X-rays)
- Tunable
- "Spiky" (t and λ)

Seeding

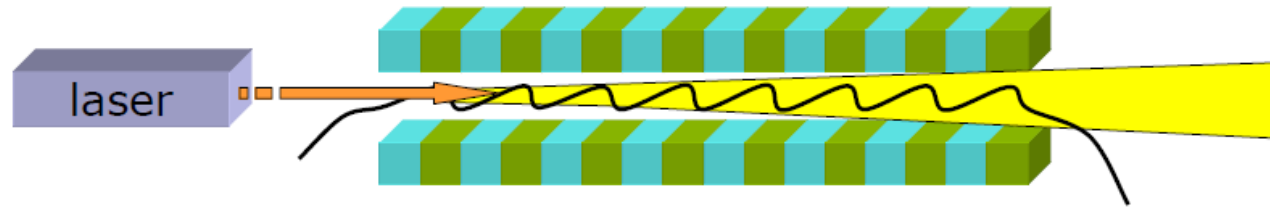

- Remove instabilities
- CHG with gain HGHG

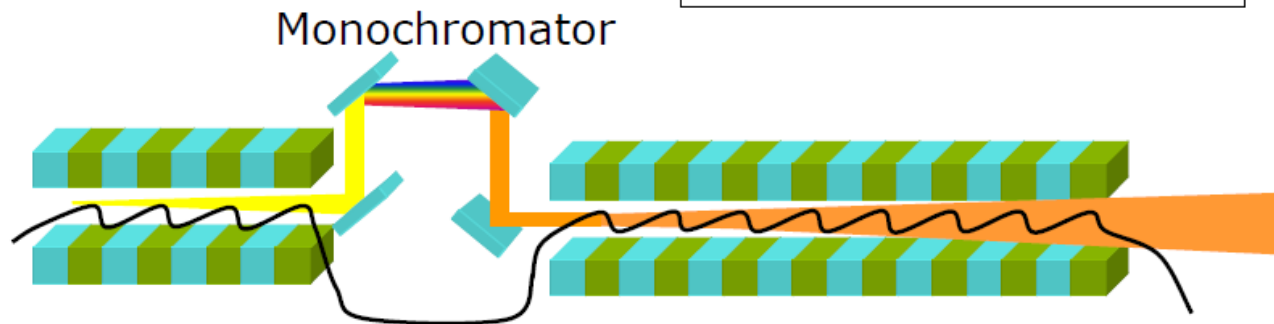

power gain

$$P(z) = \frac{P_0}{9} \exp(z / L_g) \text{ for } z \geq 2L_g$$

Key figures of FLASH

<http://flash.desy.de/>

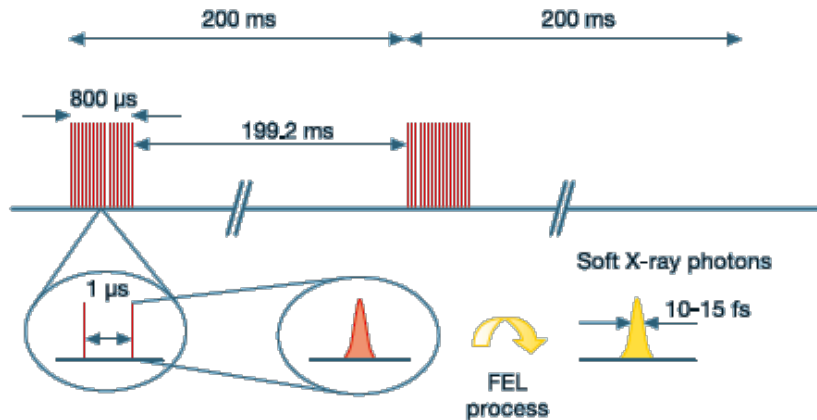

Performance of the FEL radiation

2005 – 2007

Wavelength range of the fundamental
 Higher harmonics

13 - 47 nm (from fall 2007: 6.5 nm)
 3rd 4.6 nm
 5th 2.7 nm
 (7th 1.9 nm)

Average pulse energy

up to 100 μJ

Peak pulse energy

170 μJ

Peak power

5 GW

Average power

100 mW

Pulse duration

10 - 50 fs

Spectral width

0.5 - 1%

Peak brilliance

$10^{29} - 10^{30}$

[photons/(s mrad² mm² 0.1% BW)]

http://pr.desy.de/sites2009/site_pr/content/e113/e48/column-objekt221/lbox/infoboxContent222/FLASH_en_2007_ger.pdf

Review of techniques for attosecond X-ray Pulse generation (FEL based)

Main schemes

- emittance spoiler (P. Emma et al. PRL, 2004)
- slicing: wavelength selection (Saldin et al., Opt. Comm. 2004)
- slicing: current enhancement (Zholents et al., PRSTAB 2005)
- slicing: from a Harmonic Cascade FEL (Zholents et al., PRL 2004)
- slicing: energy chirp revisited: tapered undulator (Saldin et al., PRSTAB 2006)
- ultra short electron bunches: single spike (C. Pellegrini et al., 2007)
- energy chirp (C. Schroeder et al., NIMA 2002)
- attosecond trains from mode locking (N. Thompson et al., 2007)

Thank you!

