

Course 2: Basic Technologies

Part II: X-ray optics

What do you see here?

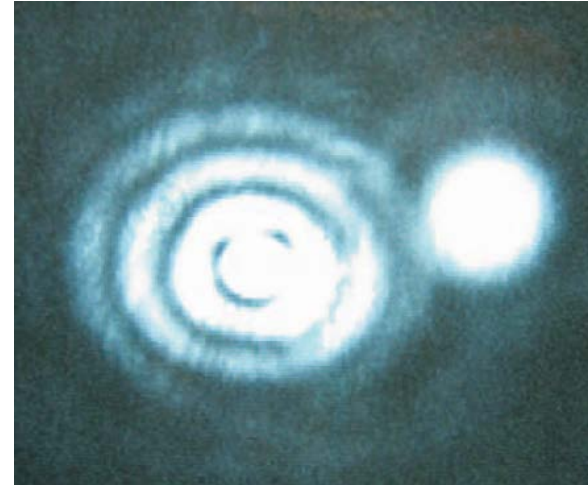
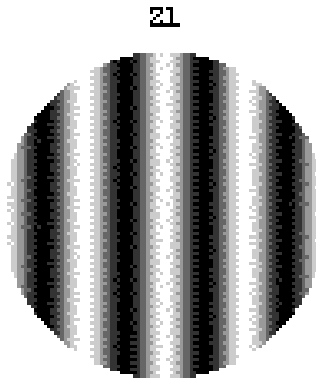

wavefront distortion

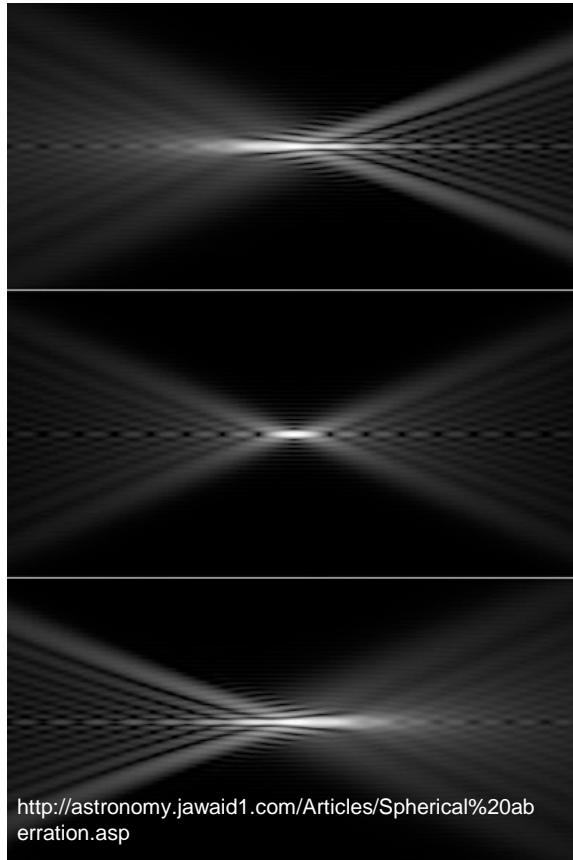

Frits Zernike

Physicist

Frits Zernike was a Dutch physicist and winner of the Nobel prize for physics in 1953 for his invention of the phase contrast microscope, an instrument that permits the study of internal cell structure ... Wikipedia



Born: July 16, 1888, Amsterdam

Died: March 10, 1966, Amersfoort

Education: Universiteit van Amsterdam

Awards: Nobel Prize in Physics, Rumford Medal

ASTIGMATISM.

In the case of an oblique bundle of rays impinging on the lens, as in Fig. 21, from a point not on the optical axis, the lens does not present a symmetrical front to the incident rays; as indicated in the figure, the lens appears foreshortened in the plane of incidence (containing optical axis PP' and point A ; usually called *tangential* or *meridional* plane). The effect of the lens is to produce an emergent wave of less radius of curvature for

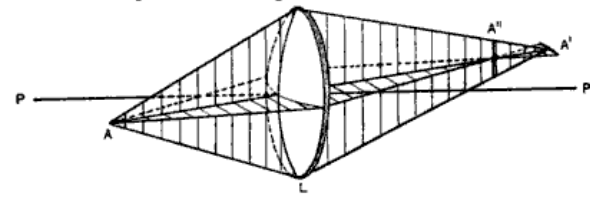

FIG. 21.

the tangential plane than for the plane normal to it (*sagittal plane*) (Figs. 21, 22*). The image formed in the tangential plane will then fall short of the image formed in the sagittal plane. The distance between the image points in the tangential and sagittal planes is the *astigmatic difference* and the aberration is called *astigmatism*. The total effect of astigmatism on an incident spherical wave is to produce an emergent wave of spherical front whose radius of curvature in the tangential plane is less or greater than that in

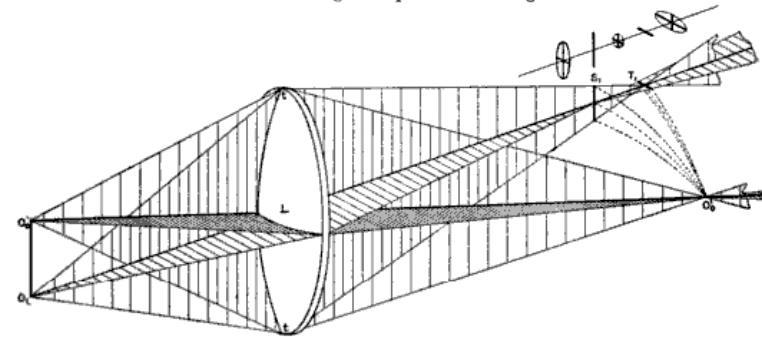

FIG. 22.

the sagittal plane; the practical consequence of this is that astigmatism produces from a plane object an image which consists of two coaxial warped and irregular surfaces. In correcting for astigmatism, the effort is made to make these two surfaces coincide for the useful field of the objective. Astigmatism is not, in general, very noticeable in microscopic objectives, because the inclination of the chief rays is comparatively small. It usually

*Fig. 22 was suggested to the writer by a drawing by Dr. H. Kellner, illustrating astigmatism.

Zernike Polynomials

The Zernike polynomials are a set of **orthogonal** polynomials that arise in the **expansion of a wavefront function** for optical systems with **circular pupils**.

The odd and even Zernike polynomials are given by

$${}^oU_n^m(\rho, \phi) = R_n^m(\rho) \sin m\phi$$

$${}^eU_n^m(\rho, \phi) = R_n^m(\rho) \cos m\phi$$

where the radial function $R_n^m(\rho)$ is defined for n and m integers with $n \geq m \geq 0$ by

$$R_n^m(\rho) = \begin{cases} \sum_{l=0}^{(n-m)/2} \frac{(-1)^l (n-l)!}{l! \left[\frac{1}{2}(n+m)-l\right]! \left[\frac{1}{2}(n-m)-l\right]!} \rho^{n-2l} & \text{for } n-m \text{ even} \\ 0 & \text{for } n-m \text{ odd} \end{cases}$$

Zernike polynomials II

Sometimes the Zernike polynomials are also denoted as

$$Z_n^{-m}(\rho, \phi) = R_n^m(\rho) \sin m\phi$$

$$Z_n^{-m}(\rho, \phi) = R_n^m(\rho) \cos m\phi$$

ϕ is the azimuthal angle with $0 \leq \phi \leq 2\pi$

ρ is the radial distance with $0 \leq \rho \leq 1$

Remember e.g. the gaussian beam:

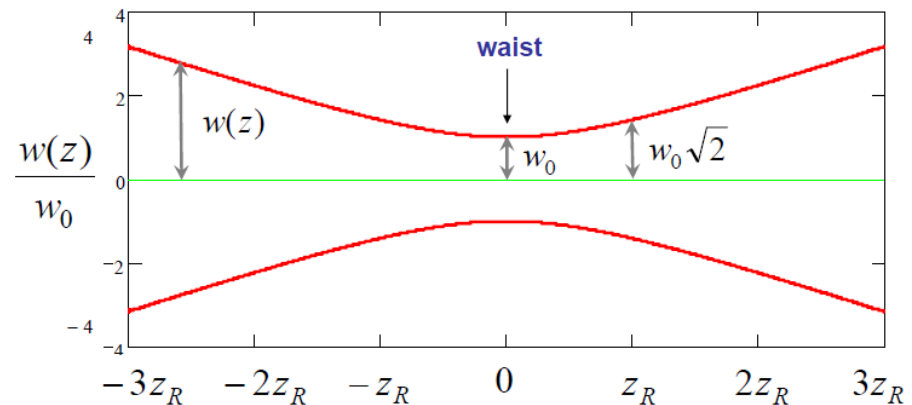

Some specific terms

$$\begin{aligned}
 z_0 &= 1; \\
 z_1 &= \rho \cos[\theta]; \\
 z_2 &= \rho \sin[\theta]; \\
 z_3 &= -1 + 2\rho^2; \\
 z_4 &= \rho^2 \cos[2\theta]; \\
 z_5 &= \rho^2 \sin[2\theta]; \\
 z_6 &= \rho(-2 + 3\rho^2) \cos[\theta]; \\
 z_7 &= \rho(-2 + 3\rho^2) \sin[\theta]; \\
 z_8 &= 1 - 6\rho^2 + 6\rho^4;
 \end{aligned}$$

Piston or Bias
Tilt x
Tilt y
Power
Astig x
Astig y
Coma x
Coma y
Primary Spherical

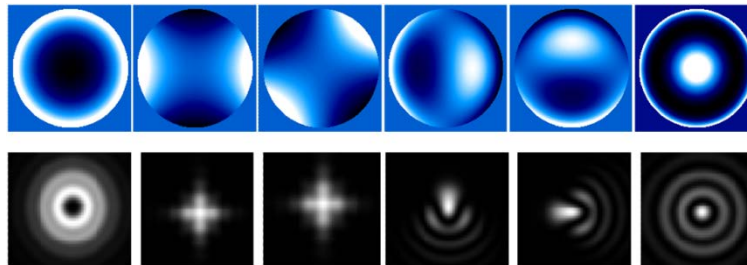

Examples of Zernike polynomials (top row) and their corresponding far-field pattern (bottom row). From left to right, you see defocus, 2 astigmatisms, 2 comas and spherical aberration.

Ji-Ping Zou and Benoit Wattellier (2012). „Adaptive Optics for High-Peak-Power Lasers“ in Adaptive Optics, Dr. Bob Tyson (Ed.), DOI: 10.5772/31750.

wavefront sensing: Shack Hartman Wavefront Sensor

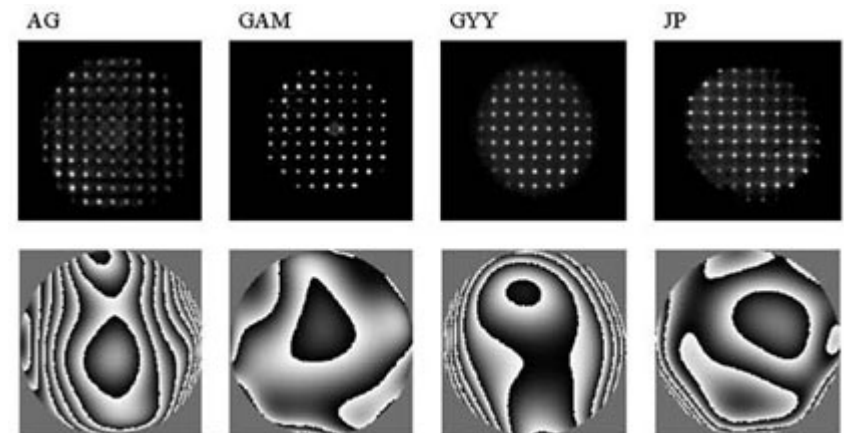
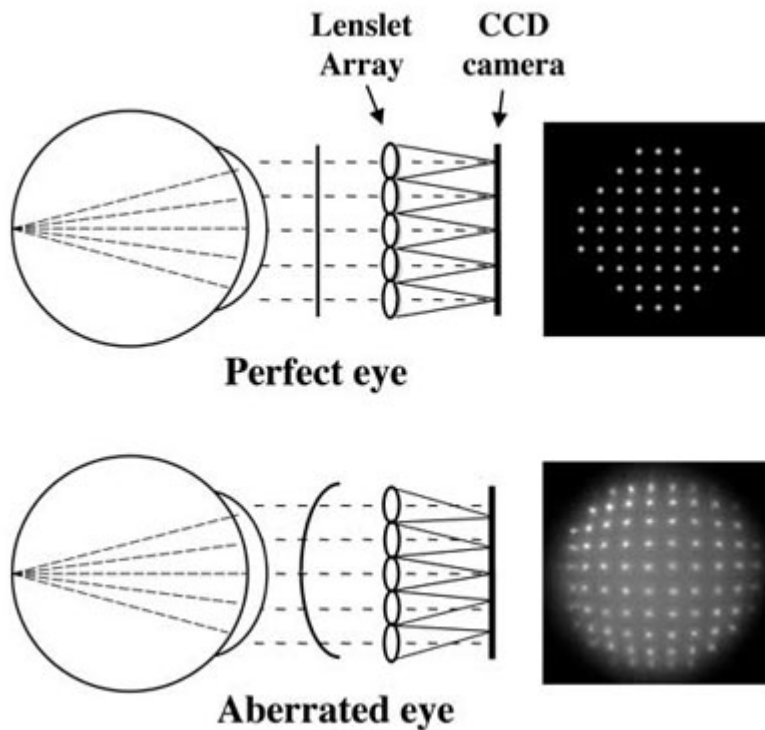

http://www.cvs.rochester.edu/williamslab/r_shackhartmann.html

Shack Hartmann LIVE

Peak-to-valley = 1.324 waves
 RMS = 0.258 waves

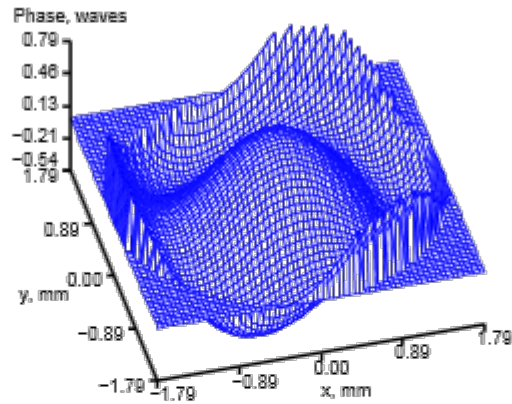

FrontSurfer v1.3.1 for deformable mirrors
 File Options Processing Preview Mirror Help
 Wavefront is ready
 Main pattern - "coma1_main.bmp" (50%)
 Reference pattern - "coma1_ref.bmp" (50%)
 Far field intensity
 Interferogram
 Sensor parameters
 Report

Wavefront surface
 Peak-to-valley = 1.170 waves
 RMS = 0.260 waves
 Wavelength = 0.630 mic
 Phase, waves
 y, mm
 x, mm

Far field intensity
 Strehl = 0.011
 y, λ/D
 x, λ/D

Sensor parameters
 PICTURE SOURCE
 file
 camera
 REFERENCE GRID
 hexagonal
 square
 Number of spots: 91
 Reference grid order: 6
 Reference grid pitch: 0.35 mm
 Pixel width: 0.008292 mm
 Pixel height: 0.008319 mm
 Smoothing filter size: 15 pixels
 Mask-to-CCD distance: 15.590949 mm
 Number of Zernike terms: 44
 SVD max-to-min ratio: 90
 Radius of the reconstruction area: 0.85
 Wavelength: 0.63 mic

Report
 Test report, generated on
 Thu Aug 21 11:30:36 AM
 Parameters:
 Decomposition area diameter = 3.624074e+000 mm
 Reconstruction area diameter = 3.034463e+000 mm
 Wavelength = 6.300000e-001 mic
 Strehl factor: 1.090490e-002
 Phase peak-to-valley = 1.169801e+000 waves
 Phase RMS = 2.598054e-001 waves
 Zernike coefficients:
 C[1,-1] = -1.065206e+000 waves (tip)
 C[1,-1] = 1.032030e+000 waves (tilt)
 C[2,0] = 0.000000e+000 waves (focus)
 C[2,2] = -5.061331e-002 waves (astigmatism)
 C[2,-2] = -3.684235e-002 waves (astigmatism)
 C[3,-1] = -9.000000e-001 waves (coma)
 C[3,-1] = -3.343409e-002 waves (coma)
 C[3,3] = -4.538190e-002 waves (trifoli)
 C[3,-3] = -3.478118e-002 waves (trifoli)
 C[4,0] = 3.135426e-002 waves (spherical aberration)
 C[4,2] = -4.442167e-002 waves
 C[4,-2] = -5.405736e-002 waves

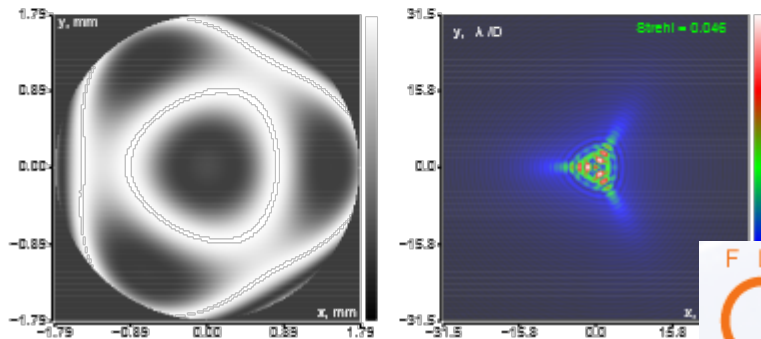

Zernike Modes LIVE!



□ Direct control of Zernike modes using piezo and membrane DM

Direct control of Zernike modes is beneficial in feedforward control algorithms, and in optimization-based adaptive optics, such as laser intracavity AO, adaptive image sharpness control, smart PSF control in microscopy, optimal imaging through turbulence with stochastic optimization, etc. In all these cases the dynamic control of Zernike modes provides for very quick quasi-optimal convergence to the maximum value of the target function.

Here we show a 15 mm 37-channel OKO Micromachined Membrane Deformable Mirror (MMDM) and 30 mm 37-channel Piezoelectric Deformable Mirror (PDM) operated by Zernike polynomials in feedforward control mode. *No wavefront sensor* is used during the mirror operation. Both mirrors are controlled by our free [MiZer software](#).

http://www.youtube.com/watch?v=Rysr6yOcAEQ&feature=player_embedded

If the orthonormal set of Zernike is used, the Zernike representation leads quickly to the wave front RMS, by the formula:

$$\sigma^2 = \sum_{m,n} Z_{mn}^2$$

<http://wyant.optics.arizona.edu/zernikes/zernikes.htm>

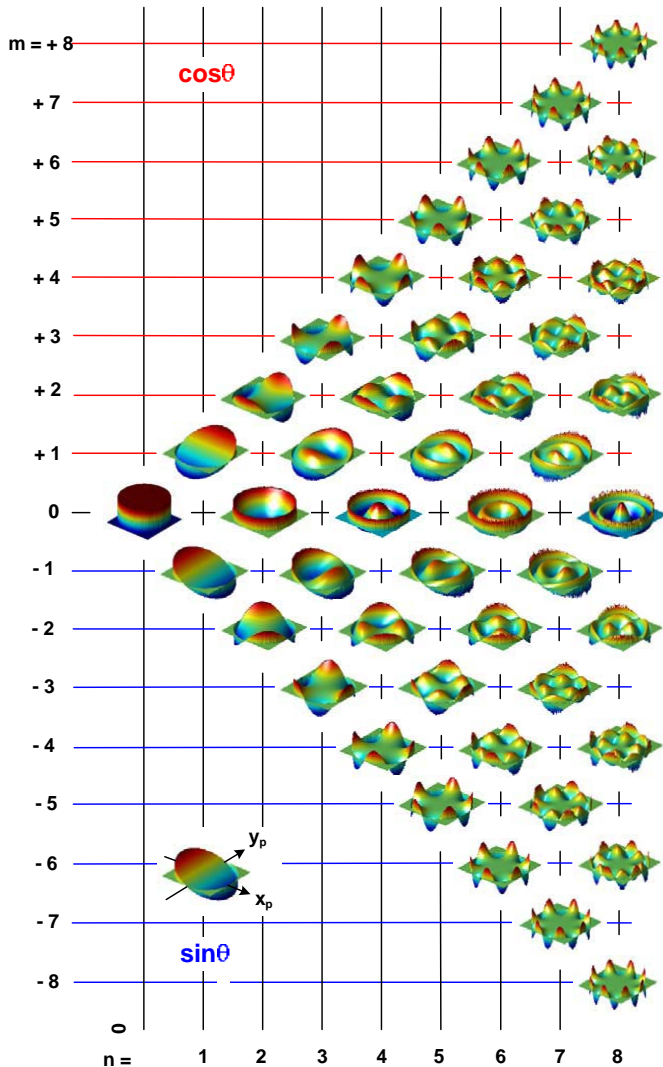

X-ray Optics

Refractive from the IR to the x-ray region of the electromagnetic spectrum

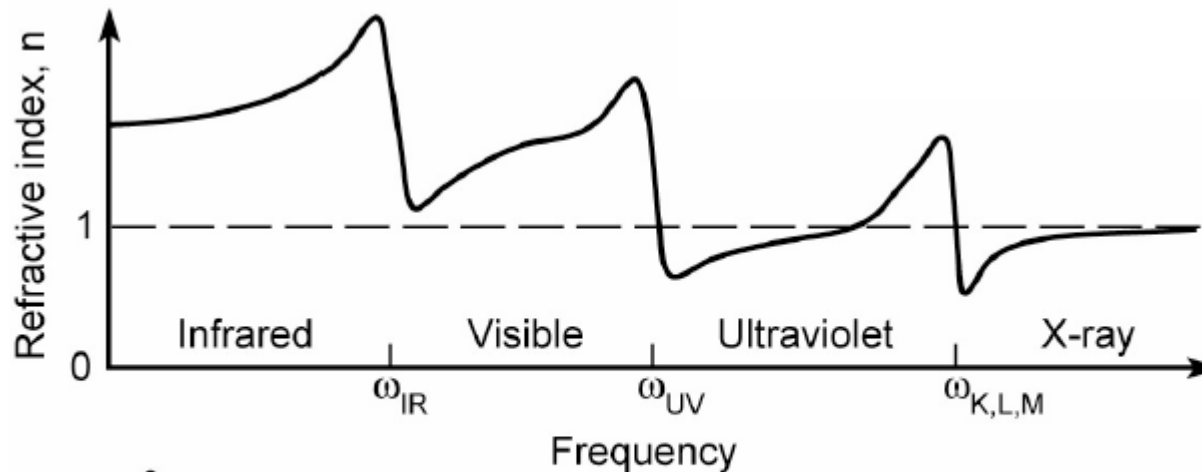

- λ^2 behavior
- δ & $\beta \ll 1$
- δ -crossover

Attwood, D.; Soft X-Ray and Extreme Ultraviolet Radiation, Cambridge University Press, 1999

Reflection and refraction of EUV/soft x-ray radiation

The refractive index, $n(\omega)$, is complex because EUV/soft x-ray radiation is absorbed appreciably by all atoms. This is reflected in the semi-classical model

$$n(\omega) = 1 - \frac{1}{2} \frac{e^2 n_a}{\epsilon_0 m} \sum_s \frac{g_s}{(\omega^2 - \omega_s^2) + i\gamma\omega}$$

where again $\sum_s g_s = Z$ (2.73), or by its quantum mechanical equivalent $\sum_{k,n} g_{kn} = Z$.

The convention is to express scattering and refractive index in terms of a complex scattering factor, $f^0(\omega)$ specific to each element

$$f^0(\omega) = f_1^0(\omega) - i f_2^0(\omega) = \sum_s \frac{g_s \omega^2}{\omega^2 - \omega_s^2 + i\gamma\omega}$$

where the scattering factor arises from consideration of the scattered electric field due to an atom, relative to that of a free electron, a topic we will discuss again in a later lecture. Introducing the classical electron radius

$$r_e = \frac{e^2}{4\pi\epsilon_0 m c^2}$$

The refractive index can be written as

$$n(\omega) = 1 - \frac{n_a r_e \lambda^2}{2\pi} [f_1^0(\omega) - i f_2^0(\omega)]$$

or in simpler notation

Attwood, D.; Soft X-Ray and Extreme Ultraviolet Radiation, Cambridge University Press, 1999

Refractive Index from the IR to X-ray Spectral Region

$$\tilde{n} = 1 - \delta + i\beta = 1 - \frac{r_0\lambda^2}{2\pi} n_a (f_1^0 - i f_2^0)$$

δ	deviation of the refractive index from one
β	absorption index
f_1^0, f_2^0	real and imaginary part of the atomic scattering factor
n_a	number of atoms per volume
r_0	classical electron radius

Phase shift relative to vacuum propagation

For a wave propagating in a medium of refractive index $n = 1 - \delta + i\beta$

$$\mathbf{E}(\mathbf{r}, t) = \underbrace{\mathbf{E}_0 e^{-i\omega(t-r/c)}}_{\text{vacuum propagation}} \underbrace{e^{-i(2\pi\delta/\lambda)r}}_{\phi\text{-shift}} \underbrace{e^{-(2\pi\beta/\lambda)r}}_{\text{decay}}$$

the phase shift $\Delta\phi$ relative to vacuum, due to propagation through a thickness Δr is

$$\Delta\phi = \left(\frac{2\pi\delta}{\lambda} \right) \Delta r$$

- Flat mirrors at short wavelengths
- Transmissive, flat beamsplitters
- Bonse and Hart interferometer
- Diffractive optics for SXR/EUV

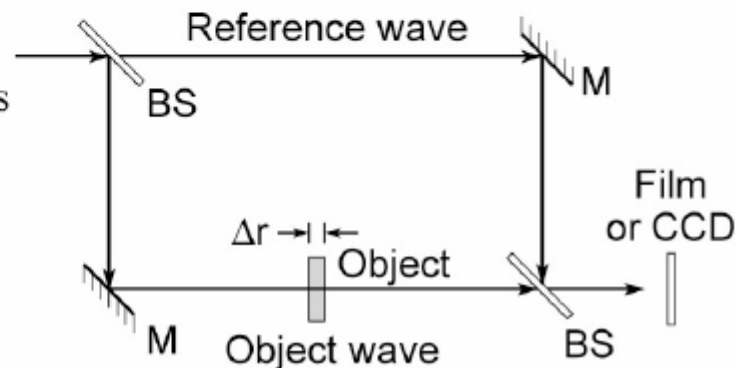

Attwood, D.; Soft X-Ray and Extreme Ultraviolet Radiation, Cambridge University Press, 1999

Spatial continuity along the interface

Continuity of parallel field components requires

$$(\mathbf{k} \cdot \mathbf{x}_0 = \mathbf{k}' \cdot \mathbf{x}_0 = \mathbf{k}'' \cdot \mathbf{x}_0) \quad \text{at } z = 0$$

$$k_x = k'_x = k''_x$$

$$k \sin \phi = k' \sin \phi' = k'' \sin \phi''$$

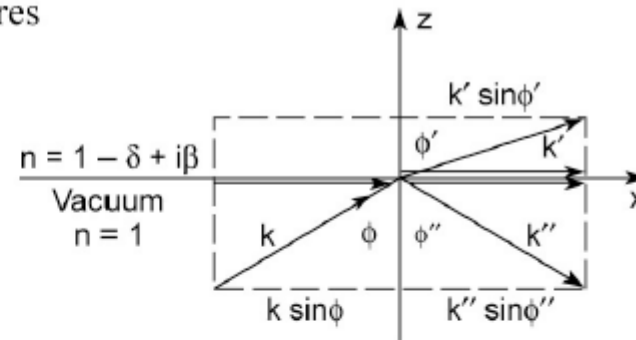

Conclusions:

Since $k = k''$ (both in vacuum)

$$\sin \phi = \sin \phi''$$

$$\therefore \boxed{\phi = \phi''}$$

The angle of incidence equals the angle of reflection

$$k \sin \phi = k' \sin \phi' \quad (3.36)$$

$$k = \frac{\omega}{c} \quad \text{and} \quad k' = \frac{\omega'}{c/n} = \frac{n\omega}{c}$$

$$\sin \phi = n \sin \phi'$$

$$\boxed{\sin \phi' = \frac{\sin \phi}{n}}$$

Snell's Law, which describes refractive turning, for complex n .

Total external reflection of soft x-ray and EUV radiation

Snell's law for a refractive index of $n \approx 1 - \delta$, assuming that $\beta \rightarrow 0$

$$\sin \phi' = \frac{\sin \phi}{1 - \delta}$$

Consider the limit when $\phi' \rightarrow \frac{\pi}{2}$

$$1 = \frac{\sin \phi_c}{1 - \delta}$$

$$\sin \phi_c = 1 - \delta$$

$$\sin(90^\circ - \theta_c) = 1 - \delta$$

$$\cos \theta_c = 1 - \delta$$

$$1 - \frac{\theta_c^2}{2} + \dots = 1 - \delta$$

$$\theta_c = \sqrt{2\delta}$$

The critical angle for total external reflection.

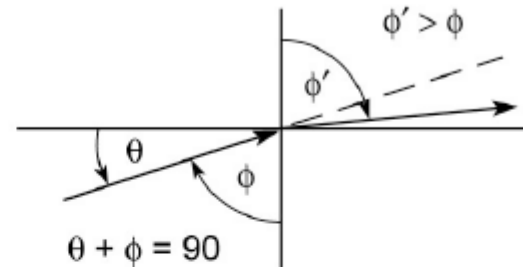

Glancing incidence ($\theta < \theta_c$) and total external reflection

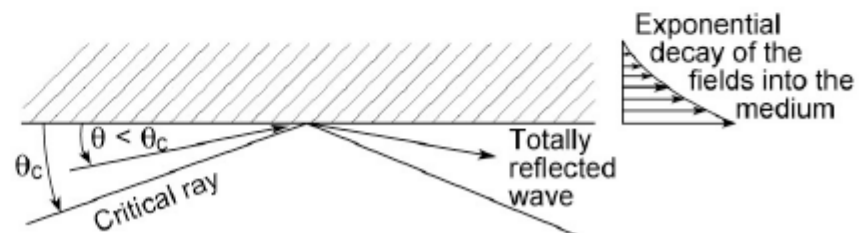

Attwood, D.; Soft X-Ray and Extreme Ultraviolet Radiation, Cambridge University Press, 1999

Total external reflection

$$\theta_c = \sqrt{2\delta}$$

$$\delta = \frac{n_a r_e \lambda^2 f_1^0(\lambda)}{2\pi}$$

$$\theta_c = \sqrt{2\delta} = \sqrt{\frac{n_a r_e \lambda^2 f_1^0(\lambda)}{\pi}}$$

The atomic density n_a , varies slowly among the natural elements, thus to first order

$$\theta_c \propto \lambda \sqrt{Z}$$

where f_1^0 is approximated by Z . Note that f_1^0 is a complicated function of wavelength (photon energy) for each element.

Galcing incidence reflection (s-polarization)

$$R_s = \frac{|\cos \phi - \sqrt{n^2 - \sin^2 \phi}|^2}{|\cos \phi + \sqrt{n^2 - \sin^2 \phi}|^2}$$

For $\theta = 90^\circ - \phi \leq \theta_c$

where $\theta_c = \sqrt{2\delta} \ll 1$

$$\cos \phi = \sin \theta \simeq \theta$$

$$\sin^2 \phi = 1 - \cos^2 \phi = 1 - \sin^2 \theta \simeq 1 - \theta^2$$

For $n = 1 - \delta + i\beta$

$$n^2 = (1 - \delta)^2 + 2i\beta(1 - \delta) - \beta^2$$

$$R_{s,\theta} = \frac{|\theta - \sqrt{(\theta^2 - \theta_c^2) + 2i\beta}|^2}{|\theta + \sqrt{(\theta^2 - \theta_c^2) + 2i\beta}|^2} \quad (\theta \ll 1)$$

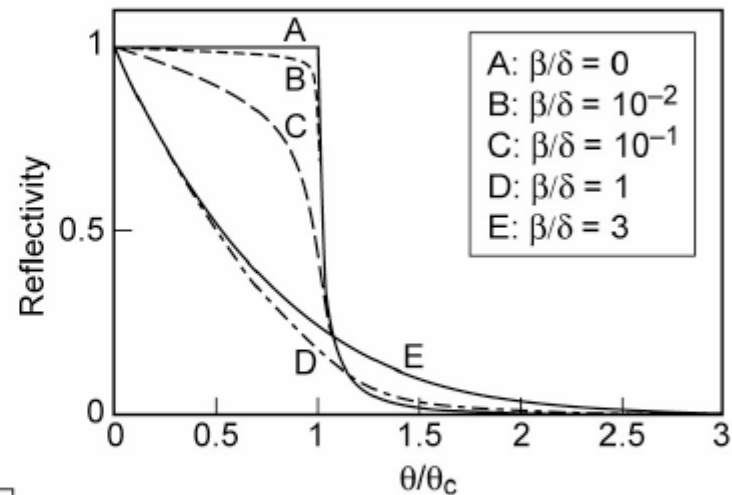

E. Nähring, "Die Totalreflexion der Röntgenstrahlen", Physik. Zeitstr. XXXI, 799 (Sept. 1930).

Attwood, D.; Soft X-Ray and Extreme Ultraviolet Radiation, Cambridge University Press, 1999

The „attosecond filter“

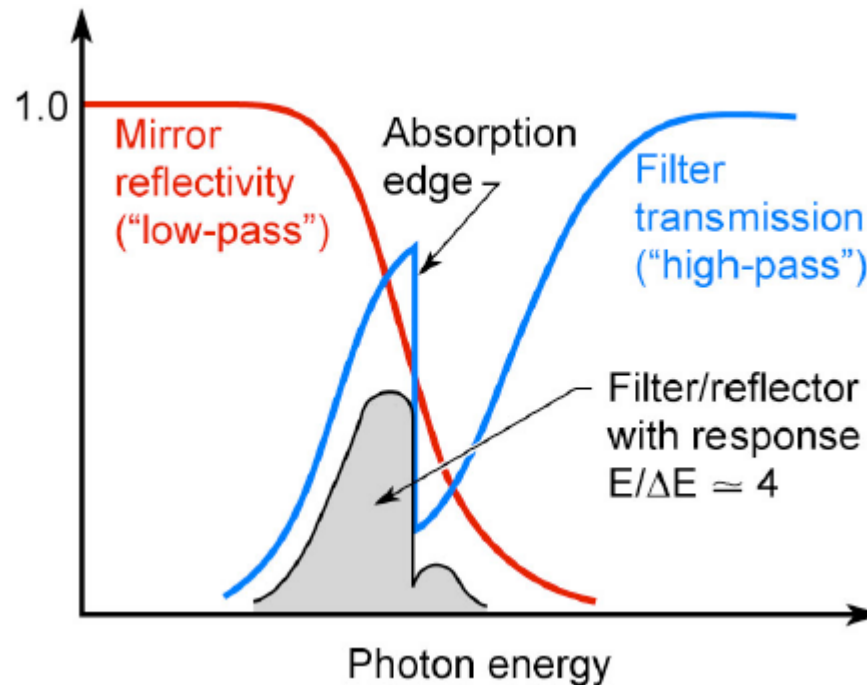

- Combines a glancing incidence mirror and a filter
- Modest resolution $E/\Delta E = 3-5$
- Commonly used

Determining f_1^2 and f_2^0

- f_2^0 easily measured by absorption
- f_1^0 difficult in SXR/EUV region
- Common to use Kramers-Kronig relations

$$f_1^0(\omega) = Z - \frac{2}{\pi} \mathcal{P}_C \int_0^\infty \frac{u f_2^0(u)}{u^2 - \omega^2} du$$

$$f_2^0 = \frac{2\omega}{\pi} \mathcal{P}_C \int_0^\infty \frac{f_1^0(u) - Z}{u^2 - \omega^2} du$$

as in the Henke & Gullikson tables

- Possible to use reflection from clean surfaces; Soufli & Gullikson
- With diffractive beam splitter can use a phase-shifting interferometer; Chang et al.
- Bi-mirror technique of Joyeux, Polack and Phalippou (Orsay, France)

Attwood, D.; Soft X-Ray and Extreme Ultraviolet Radiation, Cambridge University Press, 1999

Is there a „Brewster“ angle in the x-ray and EUV?

For p-polarization

$$R_p = \left| \frac{E_0''}{E_0} \right|^2 = \frac{\left| n^2 \cos \phi - \sqrt{n^2 - \sin^2 \phi} \right|^2}{\left| n^2 \cos \phi + \sqrt{n^2 - \sin^2 \phi} \right|^2} \quad (3.56)$$

There is a minimum in the reflectivity where the numerator satisfies

$$n^2 \cos \phi_B = \sqrt{n^2 - \sin^2 \phi_B} \quad (3.58)$$

Squaring both sides, collecting like terms involving ϕ_B , and factoring, one has

$$n^2(n^2 - 1) = (n^4 - 1) \sin^2 \phi_B$$

or
$$\sin \phi_B = \frac{n}{\sqrt{n^2 + 1}}$$

the condition for a minimum in the reflectivity, for parallel polarized radiation, occurs at an angle given by

$$\tan \phi_B = n \quad (3.59)$$

For complex n , Brewster's minimum occurs at

$$\tan \phi_B = 1 - \delta$$

or
$$\phi_B \simeq \frac{\pi}{4} - \frac{\delta}{2} \quad (3.60)$$

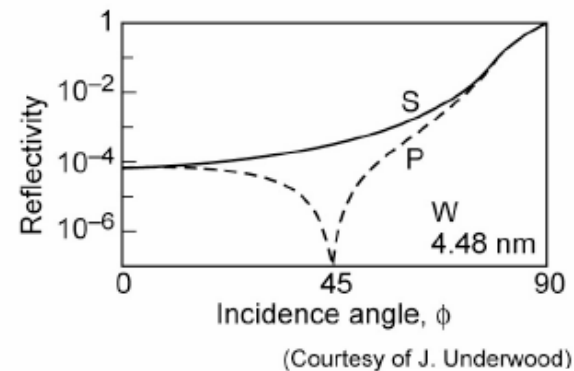
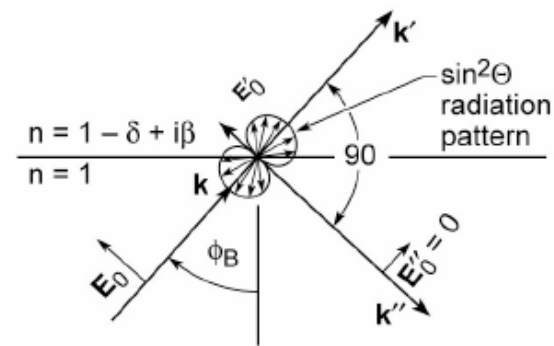

grazing incidence optics

Ellipse: $p + q = \text{constant}$, $\theta_{\text{in}} = \theta_{\text{out}}$

Focusing: equivalent optical path lengths from source-to-focus

'Ideal' mirror would have an elliptical (2D) or ellipsoidal (3D) surface figure

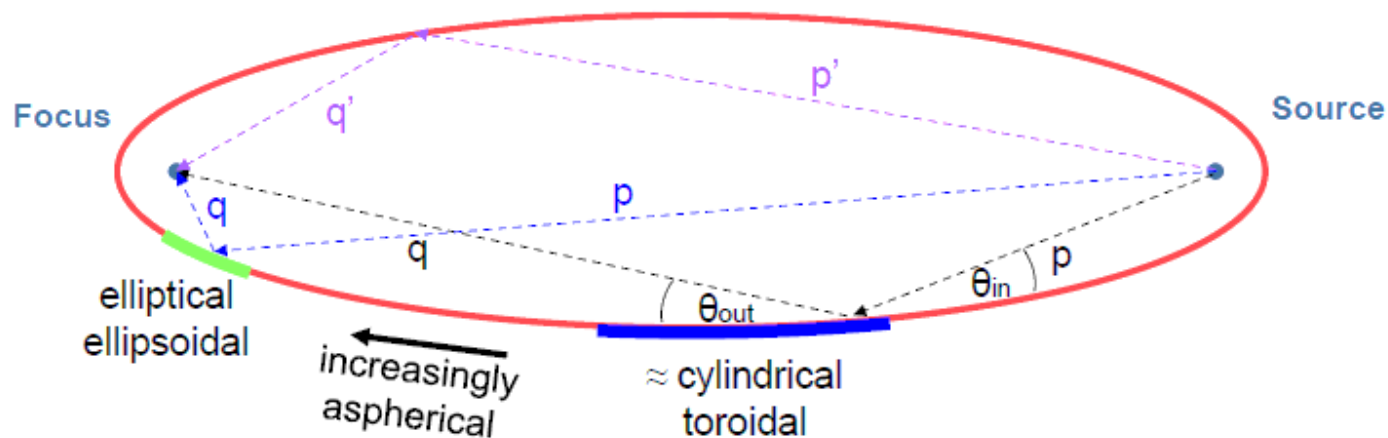

$$\text{focus size} \approx \text{source size} \times q/p$$

Micro/nanofocusing applications:

- good ellipsoidal mirrors not readily manufacturable
- perpendicular elliptical mirrors
 - Kirkpatrick-Baez (KB) configuration

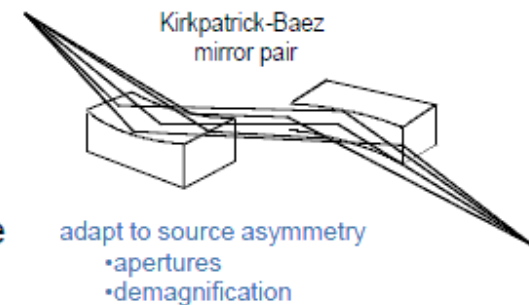

P. Kirkpatrick, A. V. Baez, Journal Opt. Soc. Am., vol. 38, pp. 766-774, 1948

Wolter optics Type I

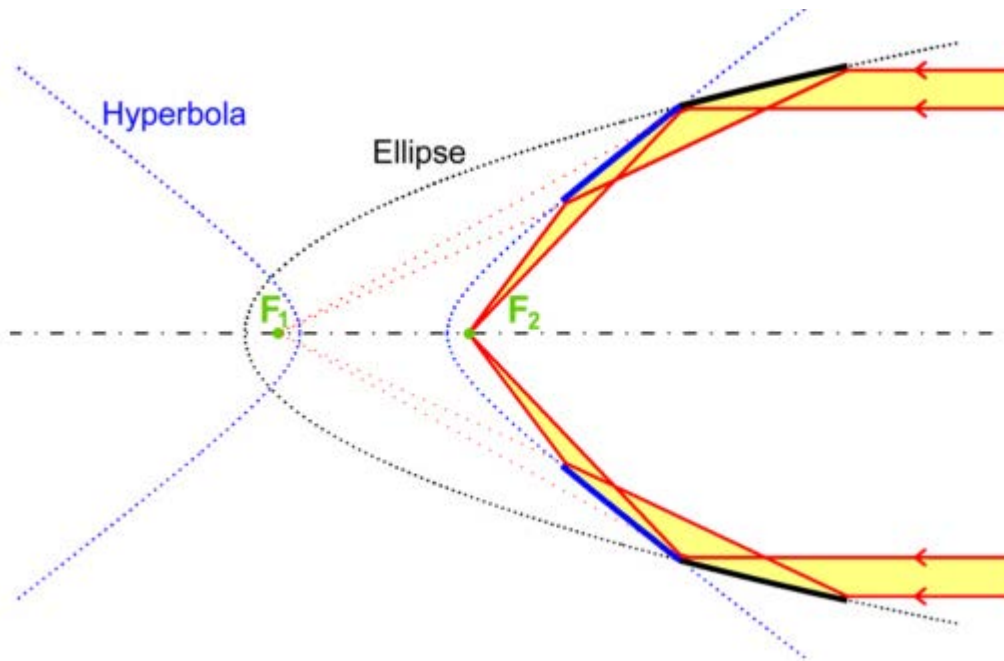
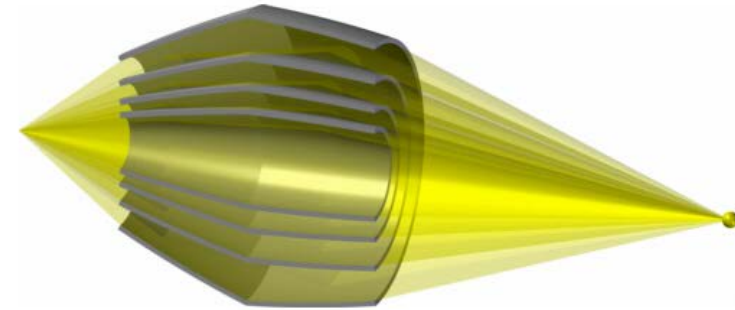

DOI: 10.1002/andp.19524450108

Wolter Optics – Type II

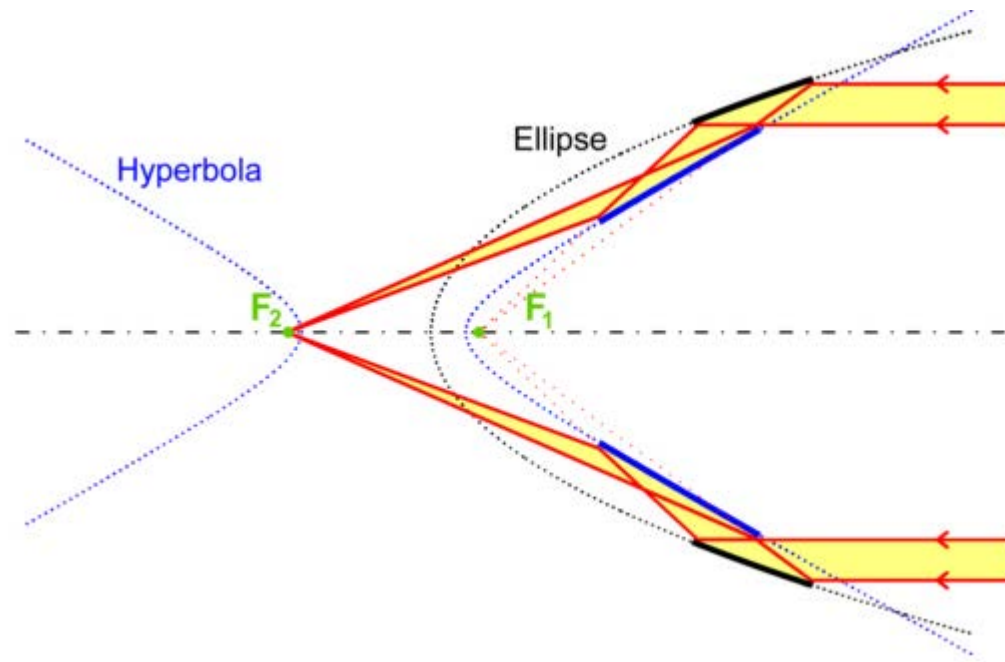

DOI: 10.1002/andp.19524450108

Wolter Optics – Type III

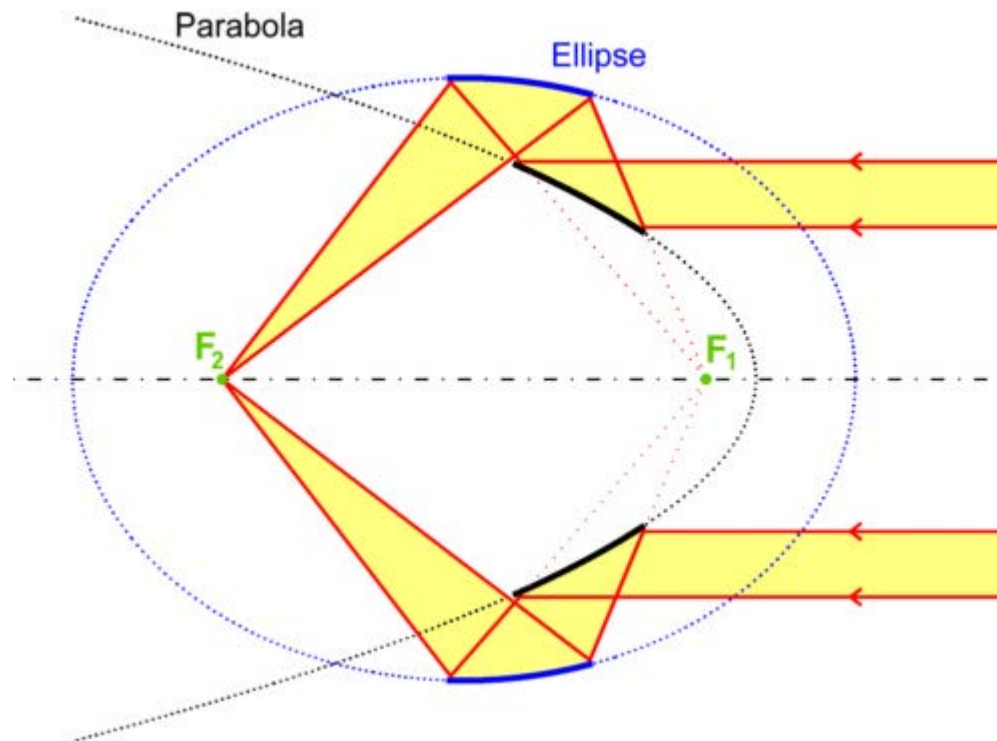

DOI: 10.1002/andp.19524450108

Schwarzschild optics

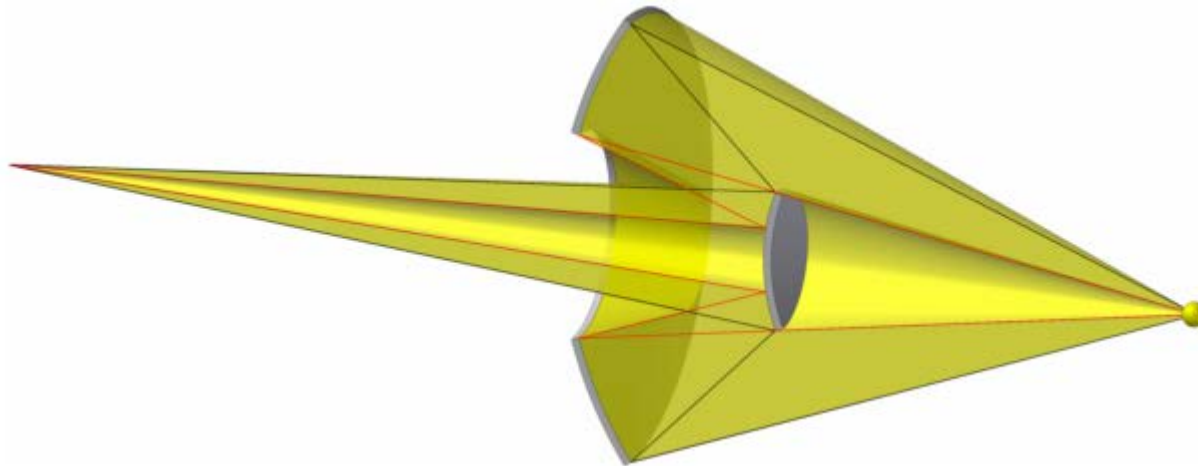

K. Schwarzschild, Untersuchungen zur geometrischen Optik, II.
Astronomische Mitteilungen der Königlichen Sternwarte zu
Göttingen, vol. 10, pp. 4-28, 1905

Zone plates

Zone Plate Lens

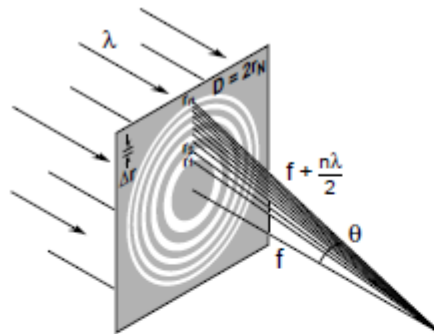

Soft X-Ray Microscope

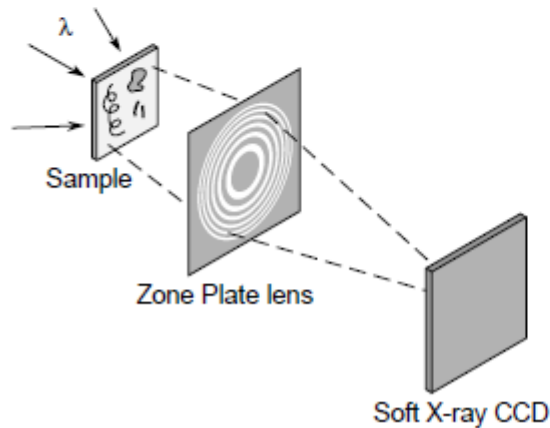

Zone Plate Formulae

$$r_n^2 = n\lambda f + \frac{n^2\lambda^2}{4} \quad (9.9)$$

$$D = 4N\Delta r \quad (9.13)$$

$$f = \frac{4N(\Delta r)^2}{\lambda} \quad (9.14)$$

$$NA = \frac{\lambda}{2\Delta r} \quad (9.15)$$

$$\text{Res.} = k_1 \frac{\lambda}{NA} = 2k_1\Delta r \quad \begin{cases} k_1 = 0.61 & 1.22\Delta r = 30 \text{ nm} \\ (\sigma = 0) \\ k_1 = 0.4 & 0.8\Delta r = 19 \text{ nm} \\ (\sigma = 0.45) \end{cases}$$

$$\text{DOF} = \pm \frac{1}{2} \frac{\lambda}{(NA)^2} \quad (9.50)$$

$$\frac{\Delta\lambda}{\lambda} \leq \frac{1}{N} \quad (9.52)$$

$\lambda = 2.5 \text{ nm}$,
 $\Delta r = 25 \text{ nm}$
 $N = 618$

63 μm

0.63 mm

0.05 μm

1.22 $\Delta r = 30 \text{ nm}$

0.8 $\Delta r = 19 \text{ nm}$

1 μm

1/700

Zone plates II

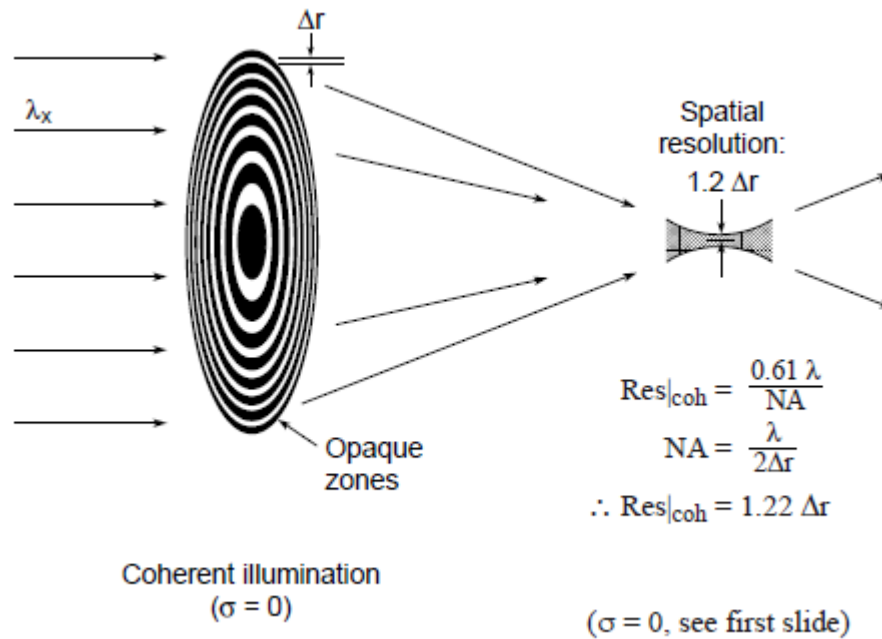

E. Anderson, LBNL

Attwood, D.; Soft X-Ray and Extreme Ultraviolet Radiation, Cambridge University Press, 1999

Zone Plate III

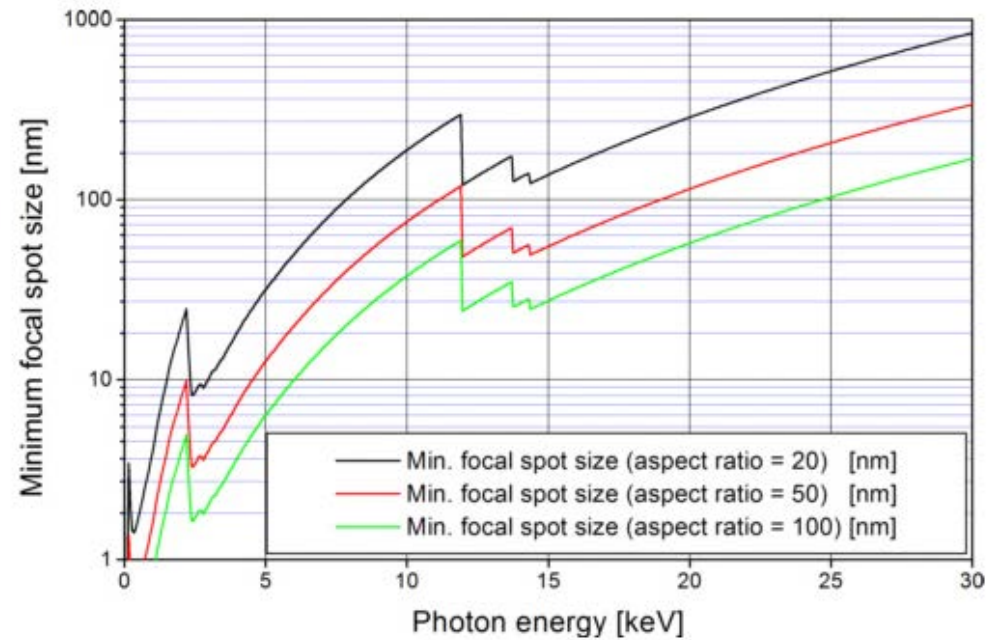
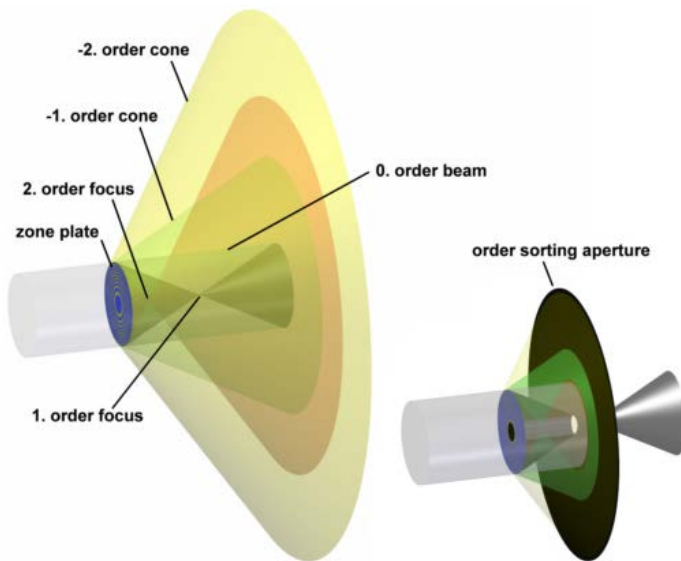

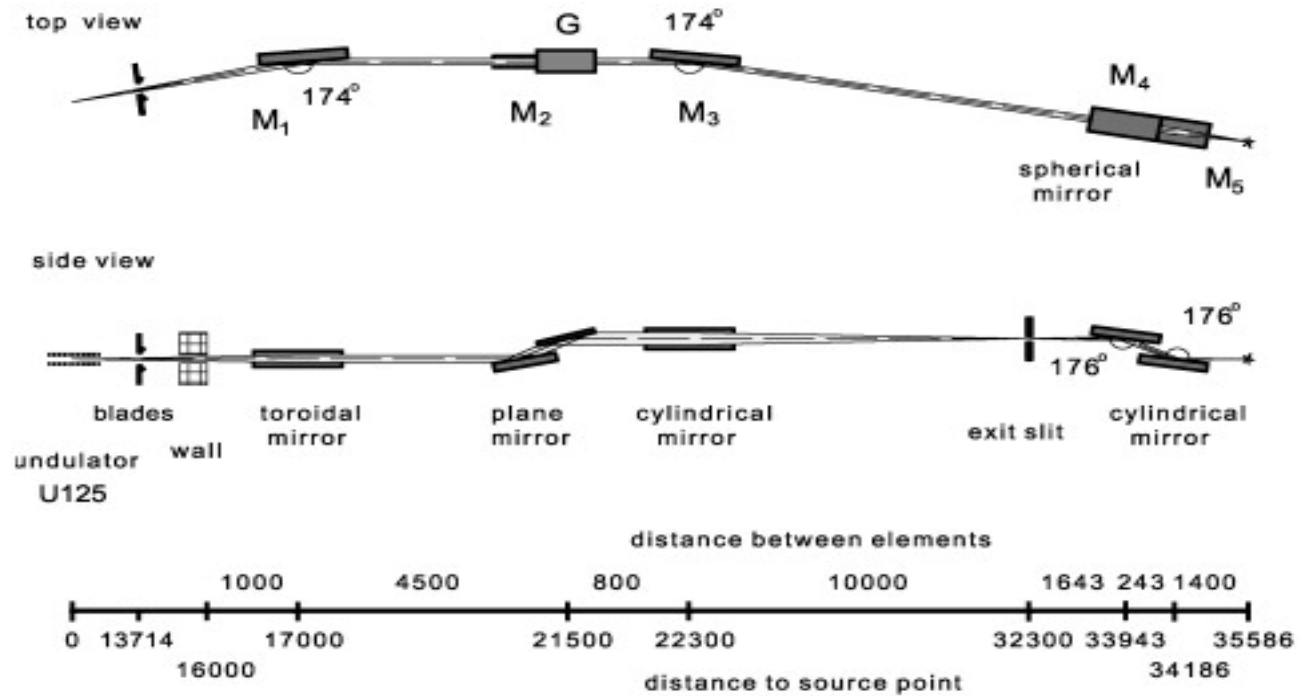

Fig. 1 Optical design of the U125/1-PGM. This monochromator was the first collimated PGM installed at BESSY II.

The versatility of collimated plane grating monochromators

Nuclear Instruments and Methods in Physics Research Section A: Accelerators, Spectrometers, Detectors and Associated Equipment Volumes 467/468, Part 1 2001 418 - 425
[http://dx.doi.org/10.1016/S0168-9002\(01\)00338-2](http://dx.doi.org/10.1016/S0168-9002(01)00338-2)

dynamic adaption to optimise focus/wavefront

major classes:

- piezoelectric bimorph systems
- mechanically actuated systems
- Extension of these technologies
 - Increased number of actuators to correct local figure errors
 - Active optics (adaptive optics)

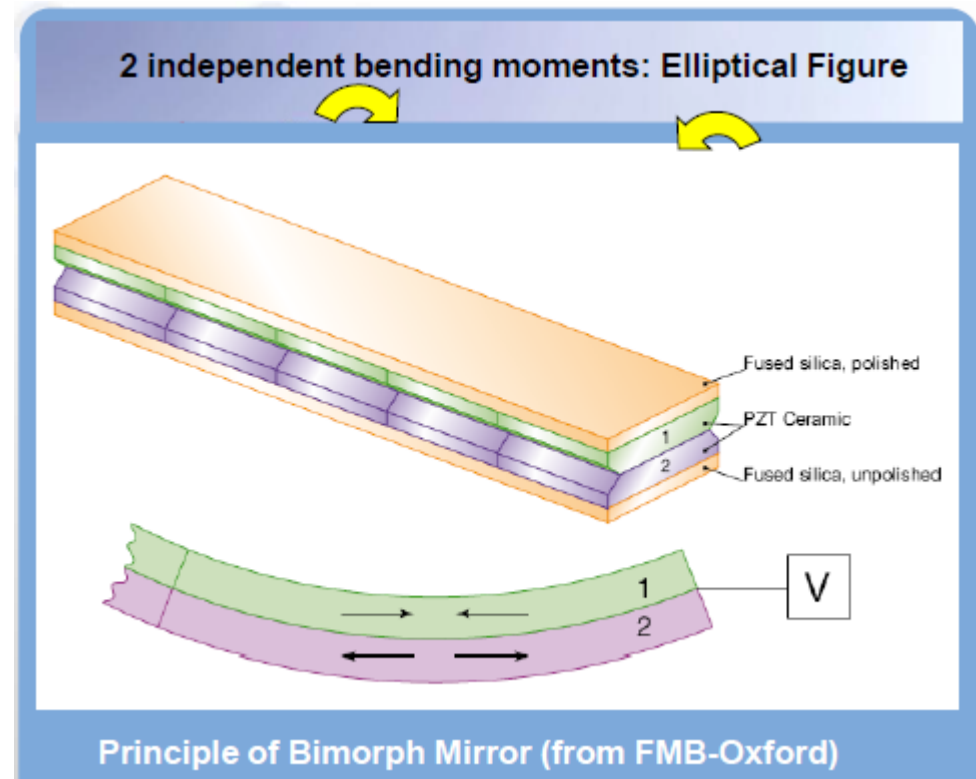

Multilayer Interference Coatings

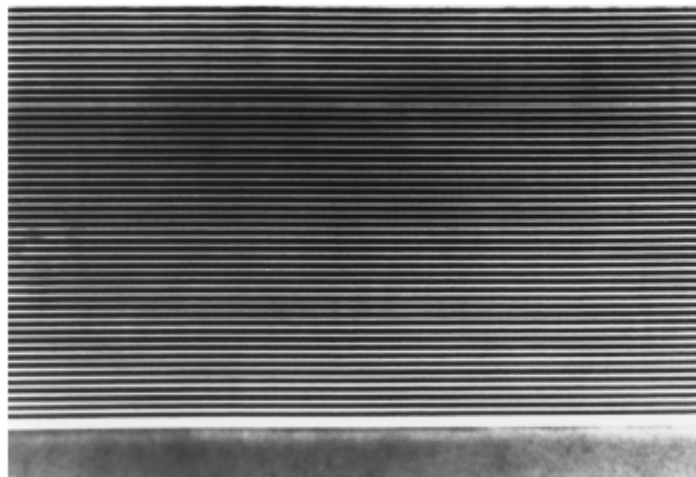

(W/C, T. Nguyen)

$$m\lambda = 2d \sin \theta$$

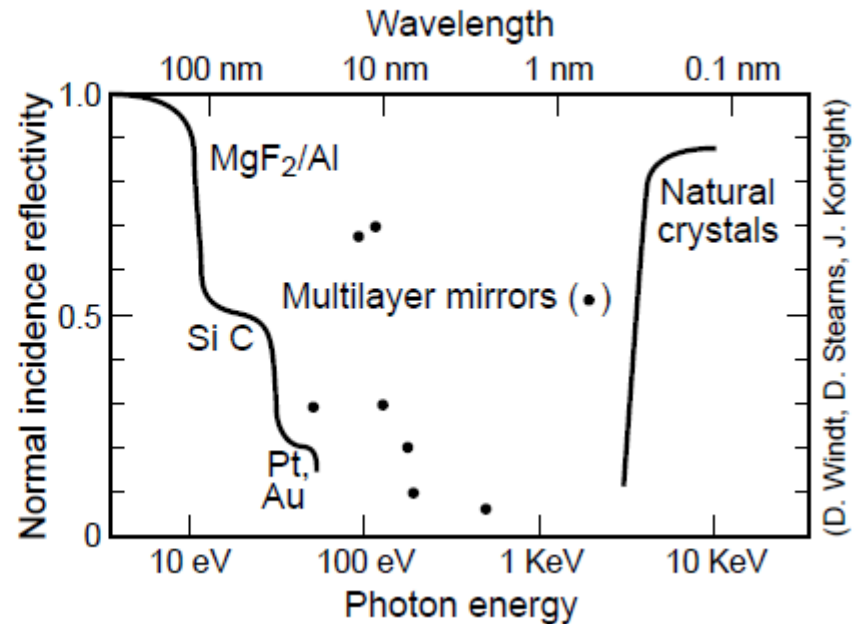

(D. Windt, D. Stearns, J. Kortright)

Attwood, D.; Soft X-Ray and Extreme Ultraviolet Radiation, Cambridge University Press, 1999

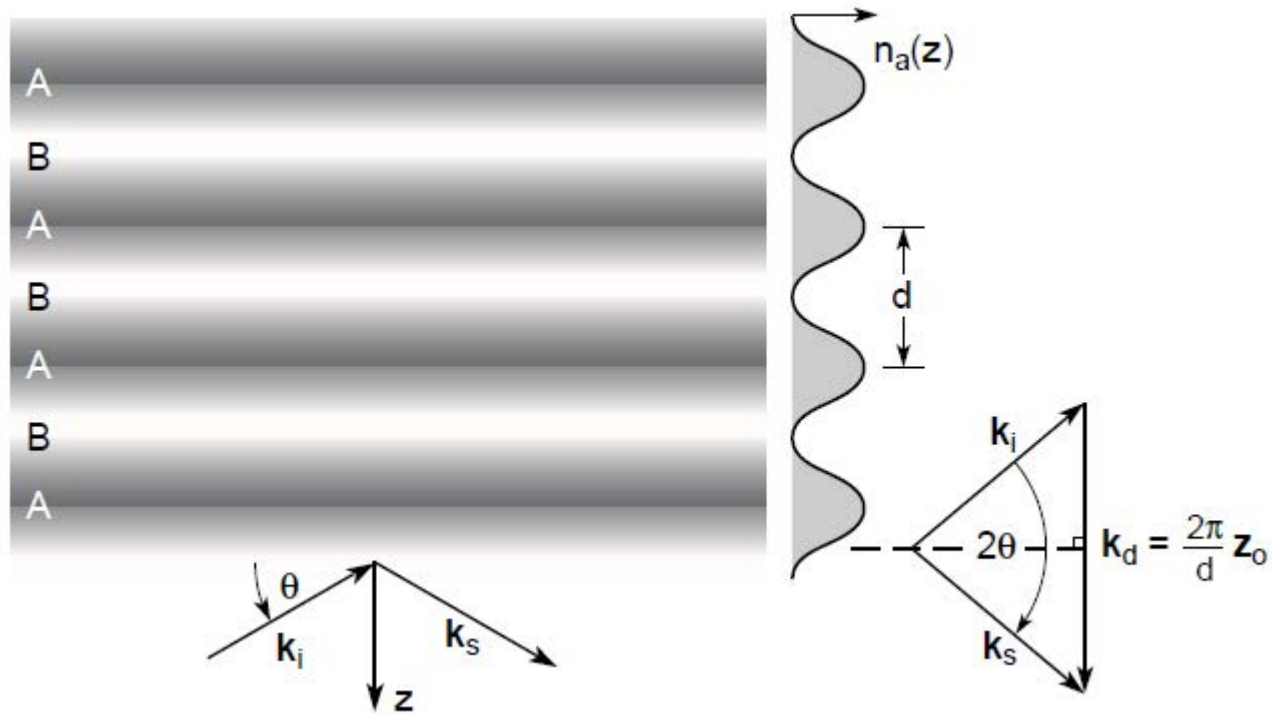

Attwood, D.; Soft X-Ray and Extreme Ultraviolet Radiation, Cambridge University Press, 1999

High Reflectivity Mirror Coatings Require

- Refractive index contrast at the interfaces
- Minimal Absorption in the low-Z material
- Thin high-Z layer where possible $\Gamma \equiv \Delta\tau_H / (\Delta\tau_H + \Delta\tau_L)$
- Interfaces which are chemically stable with time
- Minimal interdiffusion at the interfaces
- Minimal interfacial roughness (no crystallite formation with the layers, no shadowing in the coating process, surface mobility)
- Thermal stability during illumination
- Chemically stable vacuum interface (e. g. capping layer)
- Uniform coating thickness

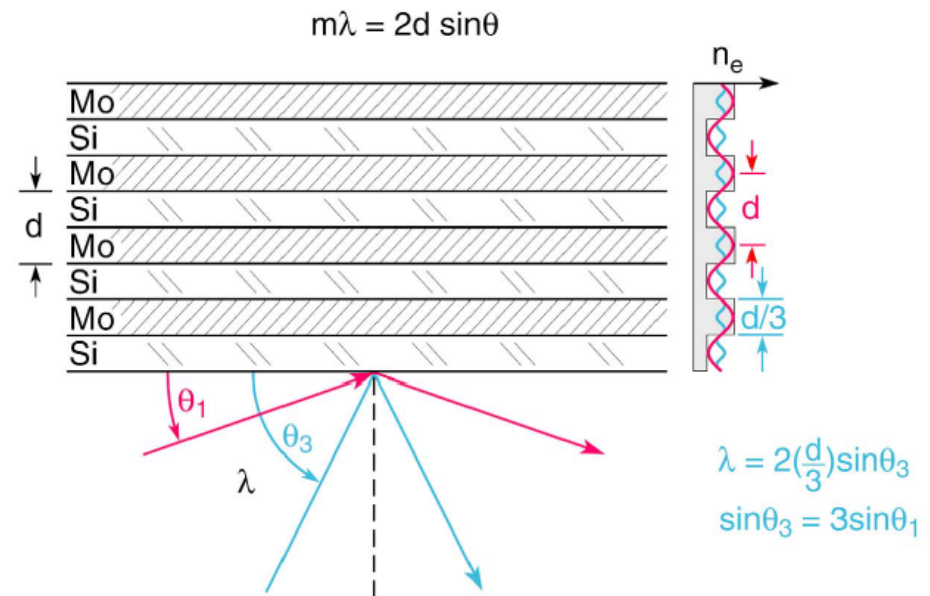
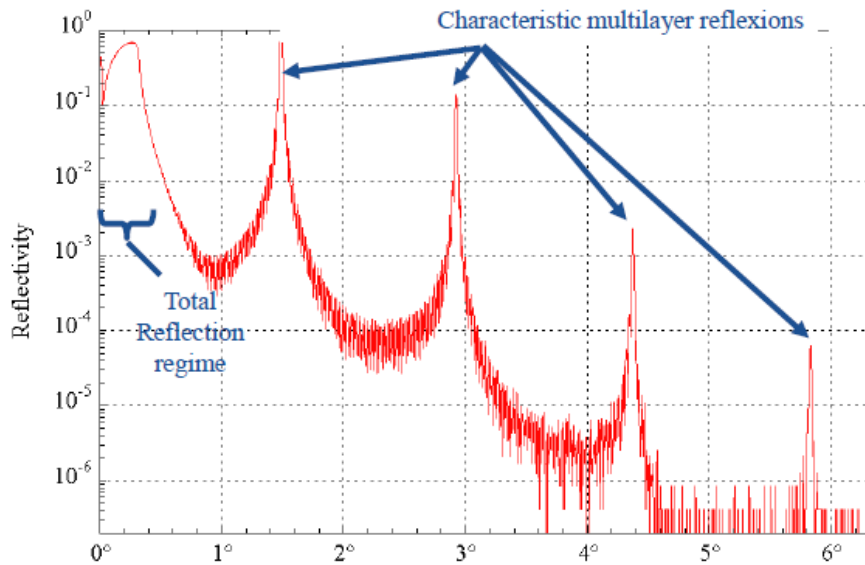

an angular scan of a multilayer mirror performs a fourier-transform of the density profile

Multilayer Interface Mirrors Computational Modelling

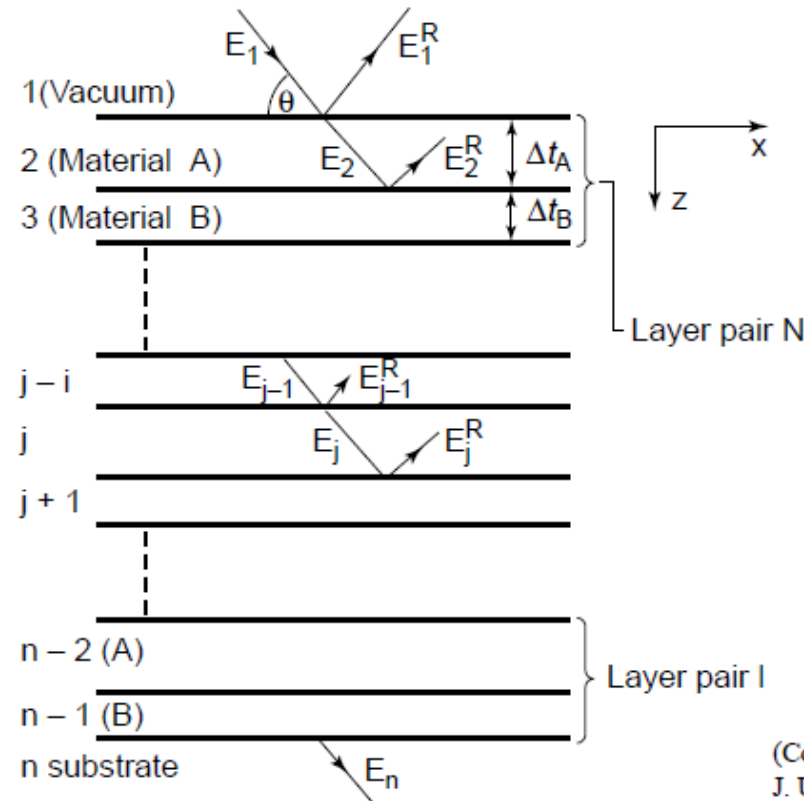

(Courtesy of J. Underwood)

With refractive index n :

$$n = 1 - \delta + i\beta = 1 - \frac{n_a r_e \lambda^2}{2\pi} (f_1^0 - if_2^0)$$

Fresnel equations

s-polarized light

$$R_s = \left| \frac{n_1 \cos \theta_i - n_2 \cos \theta_t}{n_1 \cos \theta_i + n_2 \cos \theta_t} \right|^2 = \left| \frac{n_1 \cos \theta_i - n_2 \sqrt{1 - \left(\frac{n_1}{n_2} \sin \theta_i\right)^2}}{n_1 \cos \theta_i + n_2 \sqrt{1 - \left(\frac{n_1}{n_2} \sin \theta_i\right)^2}} \right|^2$$

p-polarized light

$$R_p = \left| \frac{n_1 \cos \theta_t - n_2 \cos \theta_i}{n_1 \cos \theta_t + n_2 \cos \theta_i} \right|^2 = \left| \frac{n_1 \sqrt{1 - \left(\frac{n_1}{n_2} \sin \theta_i\right)^2} - n_2 \cos \theta_i}{n_1 \sqrt{1 - \left(\frac{n_1}{n_2} \sin \theta_i\right)^2} + n_2 \cos \theta_i} \right|^2$$

Example

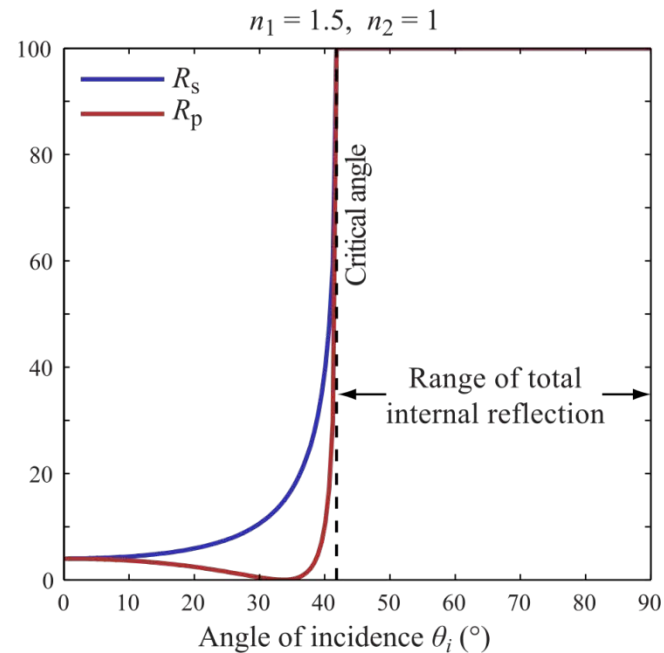
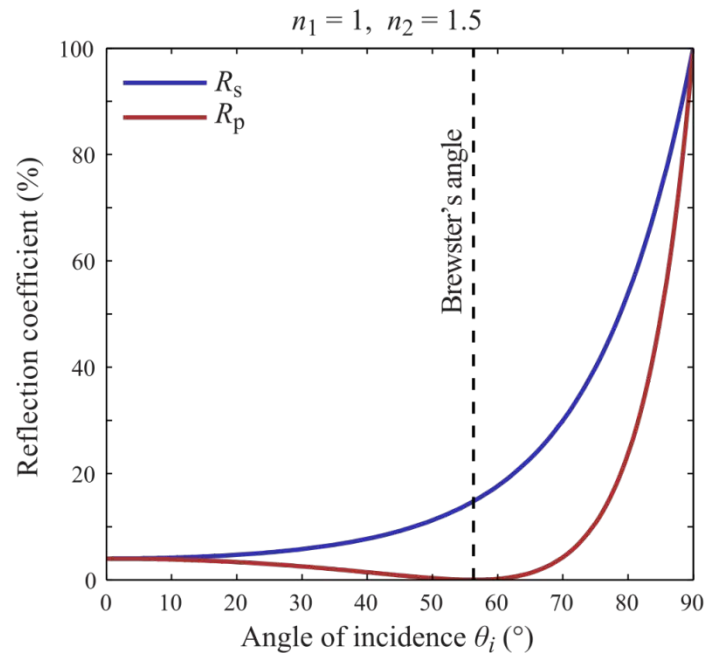

Methods to simulate multilayer mirrors

- Transfer Matrix Method
 - Abeles matrix formalism
- recursive Rouard method

simulation resources

<http://www.rxollc.com/idl/>

http://henke.lbl.gov/optical_constants/

Boundary Conditions at interfaces

The boundary conditions require that the electric and magnetic fields be continuous at each interface. This can be expressed as follows:

first interface

$$n_0 E_0 - n_0 E'_0 = n_1 E_1 - n_1 E'_1$$

second interface

$$n_1 E_1 \cdot e^{ikl} - n_1 E'_1 \cdot e^{-ikl} = n_T E_T$$

where l is the length of the medium

In matrix form this can be expressed as

$$\begin{bmatrix} 1 \\ n_0 \end{bmatrix} + \begin{bmatrix} 1 \\ -n_0 \end{bmatrix} \frac{E'_0}{E_0} = \begin{bmatrix} \cos kl & \frac{-i}{n_1} \sin kl \\ -in_1 \sin kl & \cos kl \end{bmatrix} \begin{bmatrix} 1 \\ n_T \end{bmatrix} \frac{E_T}{E_0}$$

Multiple optical interfaces

Using the following abbreviations

$$r = \frac{E'_0}{E_0} \qquad t = \frac{E_T}{E_0}$$

with r the reflection coefficient and t the transmission coefficient we can write

$$\begin{bmatrix} 1 \\ n_0 \end{bmatrix} + \begin{bmatrix} 1 \\ -n_0 \end{bmatrix} r = M \begin{bmatrix} 1 \\ n_T \end{bmatrix} t$$

The matrix M is known as the *transfer matrix*

$$M = \begin{bmatrix} \cos kl & \frac{-i}{n_1} \sin kl \\ -in_1 \sin kl & \cos kl \end{bmatrix}$$

Assuming N interfaces

For a number of N layers the total transfer matrix is derived by

$$\prod_{i=1}^N M_i = M_1 M_2 M_3 \dots M_N = M$$

$$\text{where } M = \begin{bmatrix} A & B \\ C & D \end{bmatrix}$$

thus the total reflection and transmission of a system with N interfaces is written as

$$r = \frac{An_0 + Bn_0n_T - C - Dn_T}{An_0 + Bn_Tn_0 + C + Dn_T}$$

$$t = \frac{2n_0}{An_0 + Bn_Tn_0 + C + Dn_T}$$

Transfer Matrix for periodic high reflectance films

Example:

quarter wavelength film of alternating layer of high and low refractive index materials

Transfer matrix for a double layer:

$$\begin{bmatrix} 0 & \frac{-i}{n_L} \\ -in_L & 0 \end{bmatrix} \begin{bmatrix} 0 & \frac{-i}{n_H} \\ -in_H & 0 \end{bmatrix} = \begin{bmatrix} \frac{-n_H}{n_L} & 0 \\ 0 & \frac{-n_L}{n_H} \end{bmatrix}$$

Transfer matrix for 2N layers:

$$M = \begin{bmatrix} \frac{-n_H}{n_L} & 0 \\ 0 & \frac{-n_L}{n_H} \end{bmatrix}^N = \begin{bmatrix} \left(\frac{-n_H}{n_L}\right)^N & 0 \\ 0 & \left(\frac{-n_L}{n_H}\right)^N \end{bmatrix}$$

Total reflectivity for a 2N layer film

Assuming $n_0 = 1$ for the first interface

$$R = |r^2| = \left[\frac{\left(-\frac{n_H}{n_L}\right)^N - \left(-\frac{n_L}{n_H}\right)^N}{\left(-\frac{n_H}{n_L}\right)^N + \left(-\frac{n_L}{n_H}\right)^N} \right]^2 = \left[\frac{\left(\frac{n_H}{n_L}\right)^{2N} - 1}{\left(\frac{n_H}{n_L}\right)^{2N} + 1} \right]^2$$

Smooth Multilayer Coatings are Required to Minimize Wavefront Errors in EUV Optical Systems

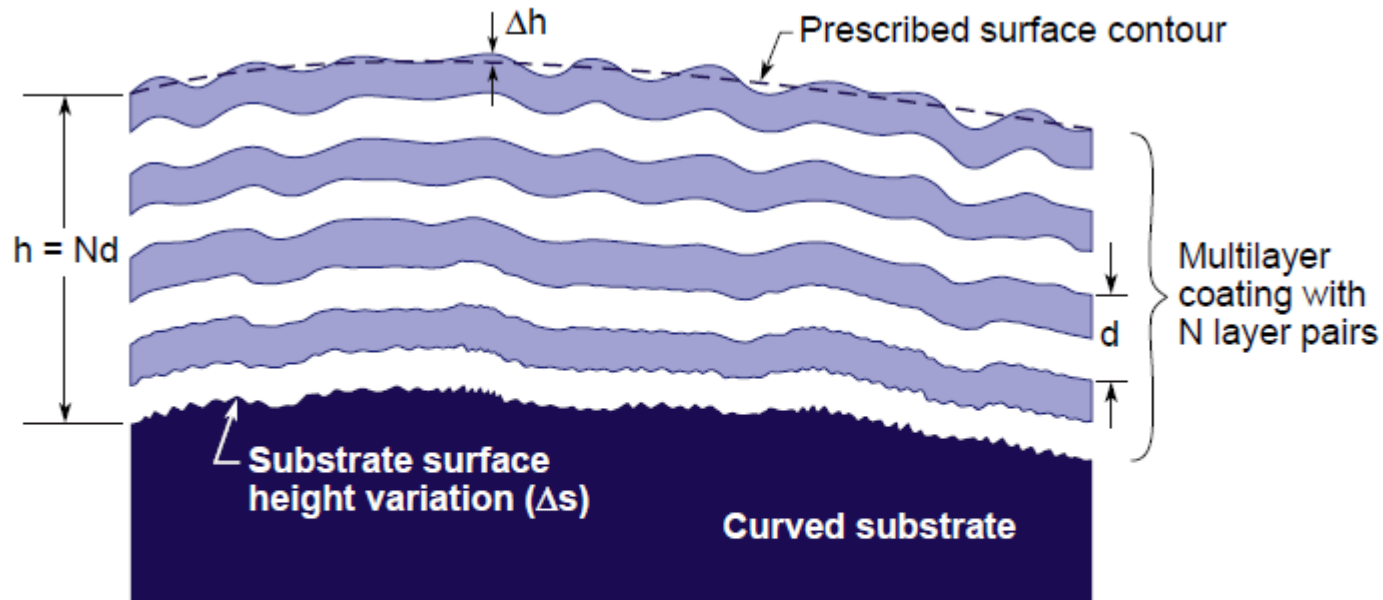

$$\Delta h = \frac{1}{2\sqrt{5}\sqrt{N_S}} \frac{\lambda}{25} \left\{ \begin{array}{l} \bullet \frac{\lambda}{25} \text{ total rms wavefront error} \\ \bullet \Delta h_{\text{rms}} = \Delta s_{\text{rms}}/2 \\ \bullet \text{double path in reflection} \end{array} \right.$$

$$\frac{\Delta d}{d} = \frac{1}{25\sqrt{5}\sqrt{N_S}N}$$

Attwood, D.; Soft X-Ray and Extreme Ultraviolet Radiation, Cambridge University Press, 1999

Example: Mo/Si Multilayer

$\sigma_a(\text{barns/atom}) = \mu(\text{cm}^2/\text{g}) \times 46.64$
 $E(\text{keV})\mu(\text{cm}^2/\text{g}) = f_2^0 \times 1498.22$

Energy (eV)	f_1^0	f_2^0	$\mu(\text{cm}^2/\text{g})$
30	3.799	3.734E-01	1.865E+04
70	2.448	5.701E-01	1.220E+04
100	-5.657	4.580E+00	6.862E+04
300	12.00	6.439E+00	3.216E+04
700	13.31	1.951E+00	4.175E+03
1000	13.00	1.070E+00	1.602E+03
3000	14.23	1.961E+00	9.792E+02
7000	14.33	4.240E-01	9.075E+01
10000	14.28	2.135E-01	3.199E+01
30000	14.02	2.285E-02	1.141E+00

Silicon (Si)
 $Z = 14$
 Atomic weight = 28.086

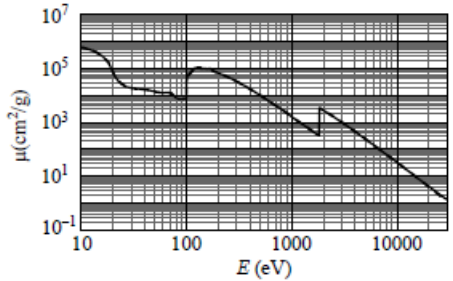
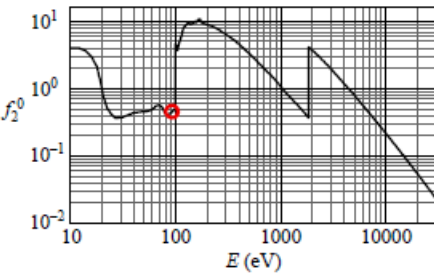
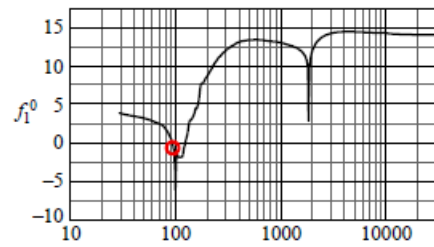

Edge Energies: K 1838.9 eV L₁ 149.7 eV
 L₂ 99.8 eV
 L₃ 99.2 eV

$\sigma_a(\text{barns/atom}) = \mu(\text{cm}^2/\text{g}) \times 159.31$
 $E(\text{keV})\mu(\text{cm}^2/\text{g}) = f_2^0 \times 438.59$

Energy (eV)	f_1^0	f_2^0	$\mu(\text{cm}^2/\text{g})$
30	1.071	5.292E+00	7.736E+04
70	19.38	4.732E+00	2.965E+04
100	14.02	1.124E+00	4.931E+03
300	4.609	1.568E+01	2.292E+04
700	31.41	1.819E+01	1.140E+04
1000	35.15	1.188E+01	5.210E+03
3000	35.88	1.366E+01	1.997E+03
7000	42.11	3.493E+00	2.189E+02
10000	41.67	1.881E+00	8.248E+01
30000	42.04	1.894E+00	2.769E+01

Molybdenum (Mo)
 $Z = 42$
 Atomic weight = 95.940

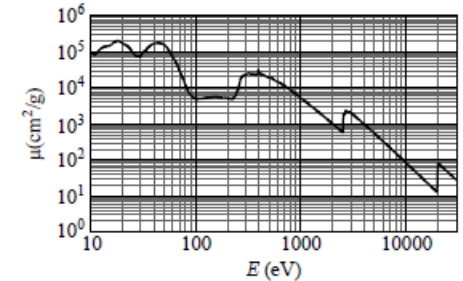
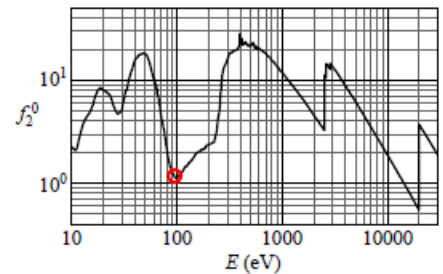
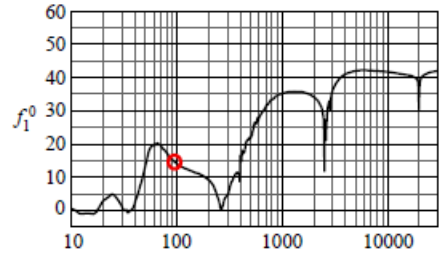

Edge Energies: K 19999.5 eV L₁ 2865.5 eV M₁ 506.3 eV N₁ 63.2 eV
 L₂ 2625.1 eV M₂ 411.6 eV N₂ 37.6 eV
 L₃ 2520.2 eV M₃ 394.0 eV N₃ 35.5 eV
 M₄ 231.1 eV
 M₅ 227.9 eV

http://henke.lbl.gov/optical_constants/

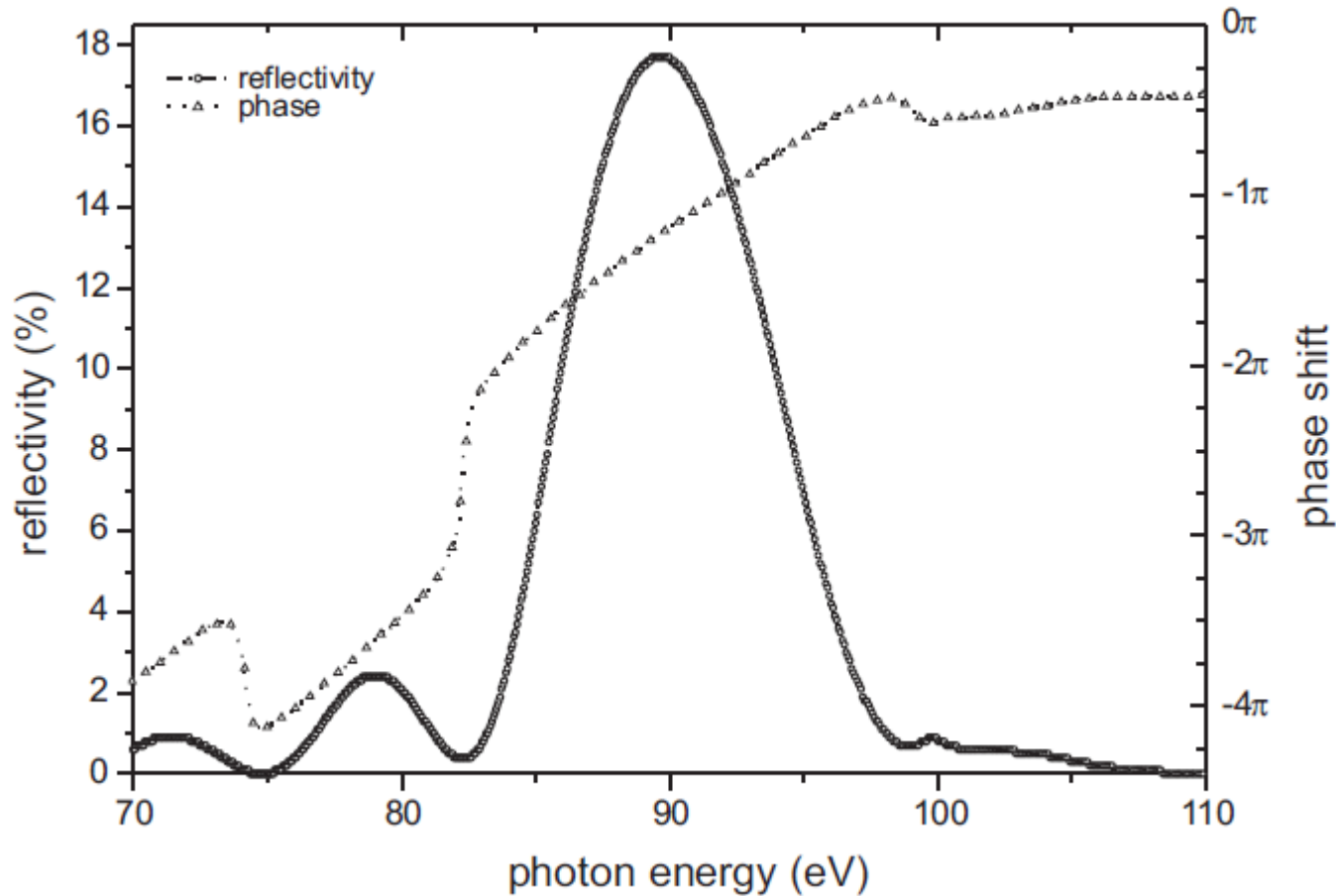

Figure 4.6: computation of the reflectivity and phase behavior of the XUV mirror used in the experiment. The reflectivity curve is already the multiplication with the transmission curve of a 150 nm Zr foil, added in the experiment to suppress the fundamental laser radiation. Measurements at the PTB at BESSYII in Berlin have shown that the type of manufacturing process for this mirror leads to a shift in the reflectivity towards higher energy in the order of 4% thus the peak reflectivity is supposed to be ~ 91 eV

Optimized Reflectivity with thin „High-Z“ Layers

$$\Gamma = \frac{\Delta t_H}{\Delta t_H + \Delta t_L} = \frac{\Delta t_H}{d} \quad (4.7)$$

$$\tan(\pi \Gamma_{\text{opt}}) = \pi \left[\Gamma_{\text{opt}} + \frac{\beta_L}{\beta_H - \beta_L} \right] \quad (4.8)$$

(Vinogradov and Zeldovich, 1977)
 (also see Borrmann, 1941)

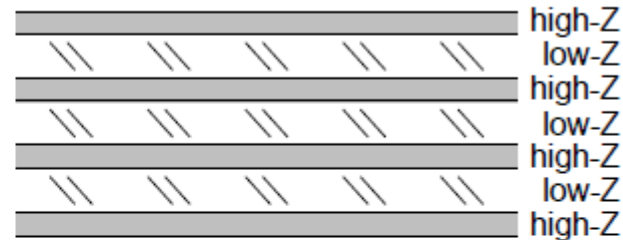

- Sharp interfaces needed for scattering
- Thin high-Z layer to minimize absorption
- Low-Z layer best as a “spacer”

Attwood, D.; Soft X-Ray and Extreme Ultraviolet Radiation, Cambridge University Press, 1999

Influence on Reflectivity

$$R = R_0 e^{-\left(\frac{4 \pi \sigma \sin \theta_g}{\lambda}\right)^2}$$

where

R_0 smooth surface reflectivity
 R attenuated reflectivity
 θ_g grazing angle of incidence
 λ wavelength of incidence
 σ rms surface roughness

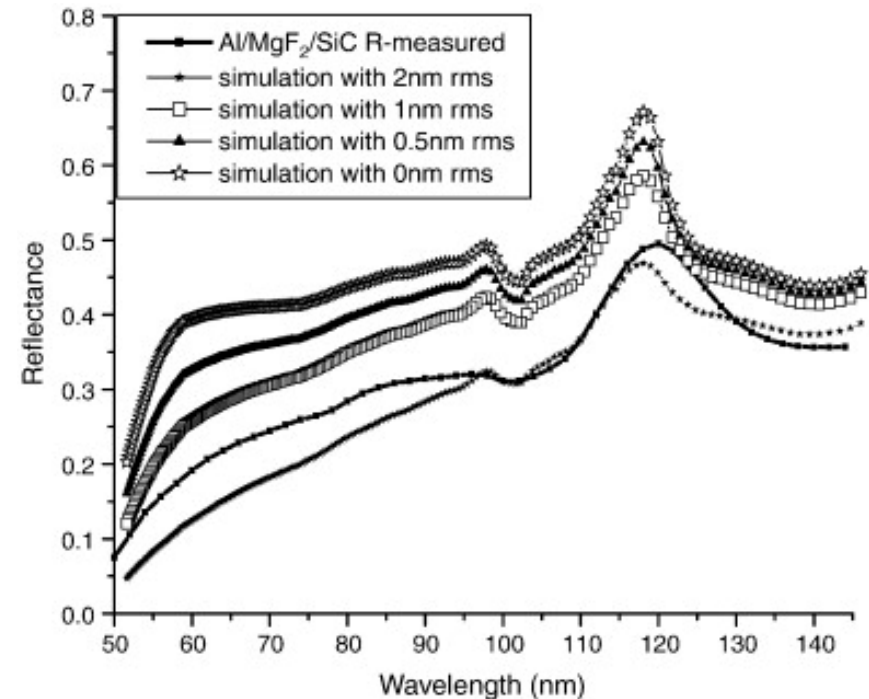

Minghong Yang et al, Thin Solid Films, Volume 517, Issue 2, 28 878-880 (2008)

Optic Simulation Software

<http://www.aor.com/>

http://www.lambdares.com/education/oslo_edu

http://www.las-cad.com/lascad_images.php

<http://www.radiantzemax.com/zemax/>

File Lens Evaluate Optimize Tolerance Source Tools Window Help

Surface Data

0.499

Gen Setup Wavelength Variables Draw On Group Notes

Lens: Lens has no title. EFL 18.848707

Ent beam radius 0.499000 Field angle 5.7296e-05 Primary wavln 0.800000

SRF	RADIUS	THICKNESS	APERTURE RADIUS	GLASS	SPECIAL
OBJ	0.000000	1.0000e+20	1.0000e+14	AIR	
AST	0.000000	0.000000	0.499000	REFLECT	C
2	0.000000	-70.000000	0.499000	AIR	C
3	800.000000	0.000000	0.499070	REFLECT	C
4	0.000000	399.945300	0.499070	AIR	C
5	0.000000	2.0000e+03	0.000468	AIR	
6	-180.000000	0.000000	2.496982	REFLECT	C
7	0.000000	-94.105800	2.496982	AIR	C
IMS	0.000000	0.000000	2.495000		

TW 1 *
Len Spe Rin Ape Wav Pxc Abr Mrg Chf Tra Sop Ref Fan Spd

Autodraw
Lens has no title.
OPTICAL SYSTEM LAYOUT
UNITS: MM
DES: OSLO

474

UW 1 - Spot Diagram Analysis

FULL FIELD
5.73e-05deg

0.7 FIELD
4.01e-05deg

ON-AXIS
0deg

FOCUS SHIFT

SPOT SIZE & FOCUS SHIFT: UNITS = mm
WAVELENGTH (nm)
WVL 0.8

Lens has no title.
SPOT DIAGRAM ANALYSIS
11 Jun 12 10:22 PM

UW 2 - Spot Diagram Analysis *

Lens has no title.
SPOT DIAGRAM
UNITS: mm

FBY 0 FBX 0
FOCUS 0

REFHT 1.641
UNITS: mm

GEOMETRICAL
RMS R SIZE
0.007589

DIFFRACTION
LIMIT
0.01282

GEOMETRICAL
RMS Y SIZE
0.003732

GEOMETRICAL
RMS X SIZE
0.006808

D.02

-0.02

- HHG generating focus (mirror, $f=399.945$ mm, Ausl 8 mm, inc_angl 6 deg)
- Aussenspiegel (mirror in 2 m Abstand von HHG spot, $r=180$ mm, Ausl 1 Zoll, inc_angl 5 deg, Ausl incl. Kern)
- Innenspiegel (Ausleuchtung 5 mm)

File Lens Evaluate Optimize Tolerance Source Tools Window Help

Surface Data

Command: 2.425

Gen Setup Wavelength Variables Draw On Group Notes

Lens: Lens has no title. EFL 18.848707

Ent beam radius 2.425000 Field angle 5.7296e-05 Primary wavln 0.800000

SRF	RADIUS	THICKNESS	APERTURE RADIUS	GLASS	SPECIAL
OBJ	0.000000	1.0000e+20	1.0000e+14	AIR	
AST	0.000000	0.000000	2.425000	REFLECT	C
2	0.000000	-70.000000	2.425000	AIR	C
3	800.000000	0.000000	2.425070	REFLECT	C
4	0.000000	399.945300	2.425070	AIR	C
5	0.000000	2.0000e+03	0.000732	AIR	
6	-180.000000	0.000000	12.126718	REFLECT	C
7	0.000000	-94.105800	12.126718	AIR	C
IMS	0.000000	0.000000	2.495000		

TW 1 *
Len Spe Rin Ape Wav Pxc Abr Mrg Chf Tra Sop Ref Fan Spd

Autodraw

Lens has no title. UNITS: MM
OPTICAL SYSTEM LAYOUT DES: OSLO

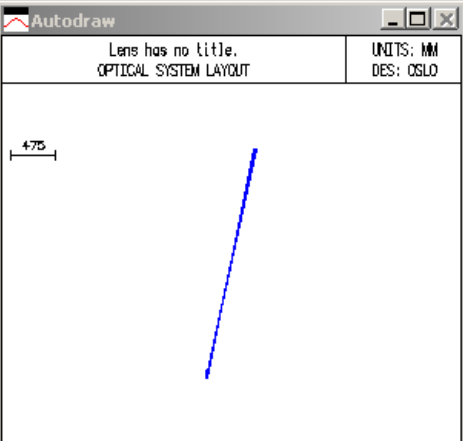

UW 1 - Spot Diagram Analysis

FULL FIELD 5.73e-05deg

0.7 FIELD 4.01e-05deg

ON-AXIS 0deg

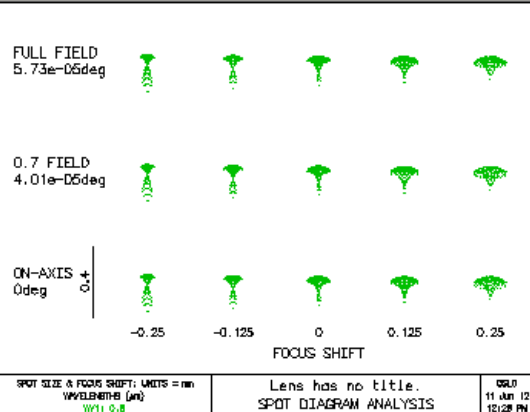

SPOT SIZE & FOCUS SHIFT: UNITS = mm
WAVELENGTH (nm) 800.0
WVL 0.8

Lens has no title. SPOT DIAGRAM ANALYSIS
OSLO 11 Jun 12 12:28 PM

UW 2 - Spot Diagram Analysis *

Lens has no title. SPOT DIAGRAM

FBY 0 FBX 0 REFHT 1.607
FOCUS 0 UNITS: mm

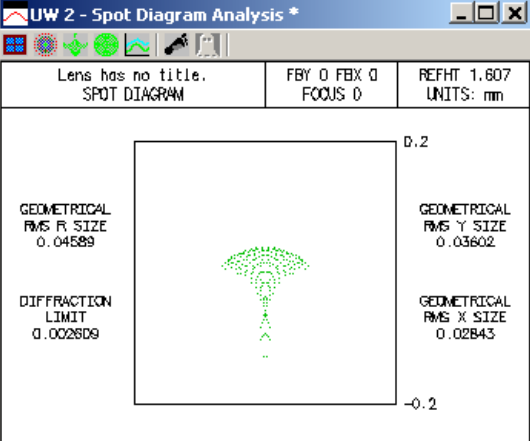

GEOMETRICAL RMS R SIZE 0.04589
DIFFRACTION LIMIT 0.002609

GEOMETRICAL RMS Y SIZE 0.03602
GEOMETRICAL RMS X SIZE 0.02843

Text output: On Page mode: Off Graphics autoclear: On

File Lens Evaluate Optimize Tolerance Source Tools Window Help

Surface Data

4.0

Gen Setup Wavelength Variables Draw On Group Notes

Lens: Lens has no title. EFL 400.000000

Ent beam radius 4.000000 Field angle 5.7296e-05 Primary wavln 0.800000

SRF	RADIUS	THICKNESS	APERTURE RADIUS	GLASS	SPECIAL
OBJ	0.000000	1.0000e+20	1.0000e+14	AIR	
AST	0.000000	0.000000	4.000000	AS REFLECT	C
2	0.000000	-70.000000	4.000000	S AIR	C
3	800.000000	0.000000	4.000070	S REFLECT	C
4	0.000000	399.945300	4.000070	S AIR	C
IMS	0.000000	0.000000	2.495000		

LJW 1 - Spot Diagram Analysis

FULL FIELD 5.73e-05deg

0.7 FIELD 4.01e-05deg

ON-AXIS 0deg

-0.8 -0.4 0 0.4 0.8

FOCUS SHIFT

SPOT SIZE & FOCUS SHIFT: UNITS = mm
WAVELENGTH (nm) 800.000000
WFL 0.8

Lens has no title. SPOT DIAGRAM ANALYSIS

OLD 11 Jun 12 09:01 PM

TW 1 *

Len Spe Rin Ape Wav Pxc Abr Mrg Chf Tra Sop Ref Fan Spd

Autodraw

Lens has no title. OPTICAL SYSTEM LAYOUT

UNITS: MM
DES: OSLO

78.2

LJW 2 - Spot Diagram Analysis *

Lens has no title. SPOT DIAGRAM

FBY 0 FBX 0 FOCUS 0

REFHT 0.001075 UNITS: mm

GEOMETRICAL RMS R SIZE 0.01572

DIFFRACTION LIMIT 0.04873

GEOMETRICAL RMS Y SIZE 0.01089

GEOMETRICAL RMS X SIZE 0.01133

D.05

-0.05

Text output: On Page mode: Off Graphics autoclear: On

Additional Sources from the WWW:

- [2nd EIROforum School on Instrumentation: X-ray Optics for Synchrotron Radiation Beamlines](#)
- [David Attwood; Soft X-Rays and Extreme Ultraviolet Radiation](#)
<http://www.youtube.com/course?list=PL6151C515014FBADA>
- [Franz Kärtner: Ultrafast Optics](#)
- Michette, A. G. (1986). *Optical Systems for Soft X Rays*. Boston, MA: Springer US. doi:10.1007/978-1-4613-2223-8

Thank you!

