

# Nonlinear Optics (WiSe 2017/18)

## Lecture 14: December 5, 2017

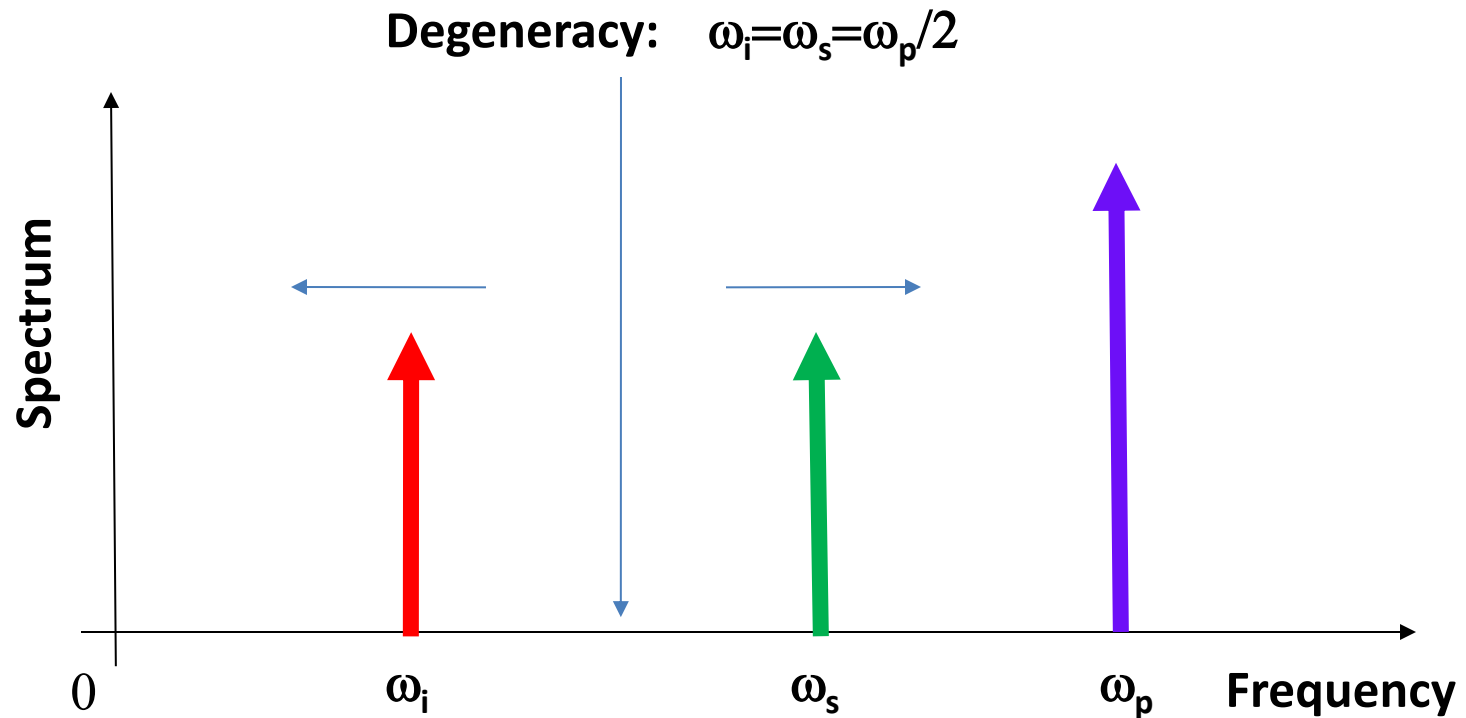
### 9 Optical Parametric Amplifiers and Oscillators

- 9.1 Optical parametric generation (OPG)
- 9.2 Nonlinear optical susceptibilities
- 9.3 Continuous-wave OPA
- 9.4 Theory of optical parametric amplification
- 9.5 Phase matching
- 9.6 Quasi phase matching (QPM)
- 9.7 Ultrashort-pulse parametric amplifiers (OPA)
- 9.8 Optical parametric amplifier designs
- 9.9 Ultrabroadband optical parametric amplifiers  
using noncollinear phase matching
- 9.10 Optical parametric chirped-pulse amplification (OPCPA)

[5] Largely follows the review paper by G. Cerullo *et al.*, “Ultrafast Optical Parametric Amplifiers,” *Rev. Sci. Instrum.* **74**, 1-17 (2003)

# 9 Optical Parametric Amplifiers and Oscillators

## 9.1 Optical Parametric Generation (OPG)



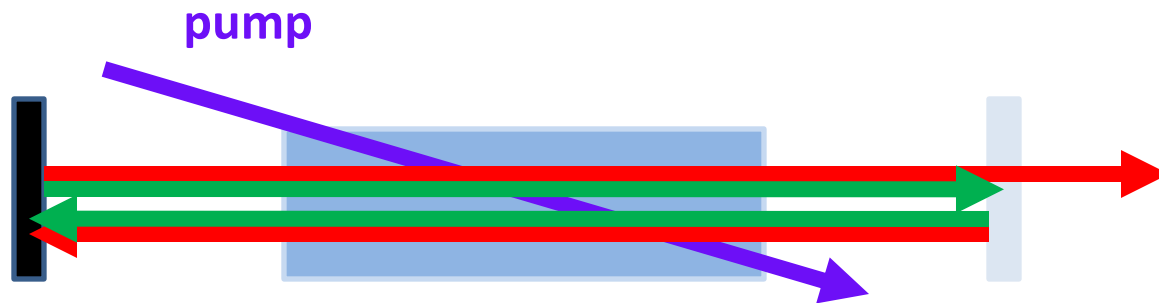
**energy conservation:**

$$\hbar\omega_p = \hbar\omega_s + \hbar\omega_i.$$

**momentum conservation:**

$$\hbar\vec{k}_p = \hbar\vec{k}_s + \hbar\vec{k}_i$$

# Optical Parametric Oscillator (OPO)



double resonant: **signal** and **idler** resonant

single resonant: **only signal** resonant

**Advantage: Widely tunable, both signal and idler can be used!**

**For OPO to operate, less gain is necessary in contrast to an OPA**

# Nonlinear Optical Susceptibilities

Total field: pump, signal and idler:

$$\vec{E}(\vec{r}, t) = \sum_{\omega_a > 0} \sum_{i=1}^3 \frac{1}{2} \left\{ \hat{E}_i(\omega_a) e^{j(\omega_a t - \vec{k}_a \vec{r})} + c.c. \right\} \vec{e}_i.$$

Drives polarization in medium:

$$\vec{P}(\vec{r}, t) = \sum_n \vec{P}^{(n)}(\vec{r}, t)$$

Polarization can be expanded in power series of the electric field:

$$\vec{P}^{(n)}(\vec{r}, t) = \sum_{\omega_b > 0} \sum_{i=1}^3 \frac{1}{2} \left\{ P_i^{(n)}(\omega_b) e^{j(\omega_b t - \vec{k}'_b \vec{r})} + c.c. \right\} \vec{e}_i.$$

Defines susceptibility tensor:

$$P_i^{(n)}(\omega_b) = \frac{\epsilon_0}{2^{m-1}} \sum_P \sum_{j \dots k} \chi_{ij \dots k}^{(n)}(\omega_b : \omega_1, \dots, \omega_n) E_j(\omega_1) \cdots E_k(\omega_n).$$
$$\omega_b = \sum_{i=1}^n \omega_i \text{ and } \mathbf{k}'_b = \sum_{i=1}^n \mathbf{k}_i$$

## Special Cases

$$\hat{P}_i^{(2)}(\omega_3) = \varepsilon_0 \sum_{jk} \chi_{ijk}^{(2)}(\omega_3 : \omega_1, -\omega_2) \hat{E}_j(\omega_1) \hat{E}_k^*(\omega_2),$$

$$\omega_3 = \omega_1 - \omega_2 \text{ und } \mathbf{k}'_3 = \mathbf{k}_1 - \mathbf{k}_2.$$

( $\longrightarrow$  Difference Frequency Generation (DFG))

$$\hat{P}_i^{(2)}(\omega_2) = \varepsilon_0 \sum_{jk} \chi_{ijk}^{(2)}(\omega_2 : \omega_3, -\omega_1) \hat{E}_j(\omega_3) \hat{E}_k^*(\omega_1),$$

$$\omega_2 = \omega_3 - \omega_1 \text{ und } \mathbf{k}'_2 = \mathbf{k}_3 - \mathbf{k}_1.$$

( $\longrightarrow$  Parametric Generation (OPG))

$$\hat{P}_i^{(3)}(\omega_4) = \frac{6\varepsilon_0}{4} \sum_{jkl} \chi_{ijkl}^{(3)}(\omega_4 : \omega_1, \omega_2, -\omega_3) \hat{E}_j(\omega_1) \hat{E}_k(\omega_2) \hat{E}_l^*(\omega_3)$$

$$\omega_4 = \omega_1 + \omega_2 - \omega_3 \text{ und } \mathbf{k}'_4 = \mathbf{k}_1 + \mathbf{k}_2 - \mathbf{k}_3.$$

( $\longrightarrow$  Four Wave Mixing (FWM))

## 9.2 Continuous-wave OPA

Wave equation :

$$\left( \Delta - \frac{1}{c_0^2} \frac{\partial^2}{\partial t^2} \right) \vec{E} = \mu_0 \frac{\partial^2}{\partial t^2} \vec{P}$$

Include linear and second-order terms:

$$\left( \Delta - \frac{1}{c_0^2} \frac{\partial^2}{\partial t^2} \right) \vec{E} = \mu_0 \frac{\partial^2}{\partial t^2} \left( \vec{P}^{(l)}(\vec{r}, t) + \vec{P}^{(2)}(\vec{r}, t) \right)$$

Changes group  
and phase  
velocities  
of waves

Nonlinear  
interaction  
of waves

$$k(\omega)$$

z-propagation only:

$$\vec{E}_{p,s,i}(z, t) = \text{Re} \left\{ E_{p,s,i}(z) e^{j(\omega_{p,s,i}t - k_{p,s,i}z)} \vec{e}_{p,s,i} \right\}$$



Wave amplitudes

$$\vec{P}_{p,s,i}^{(2)}(z, t) = \text{Re} \left\{ P_{p,s,i}^{(2)}(z) e^{j(\omega_{p,s,i}t - k'_{p,s,i}z)} \vec{e}_{p,s,i} \right\}$$

**Separate into three equations for each frequency component:**

**Slowly varying amplitude approximation:**

$$d_{p,s,i}^2 E(z) / dz^2 \ll 2k dE_{p,s,i}(z) / dz,$$

$$\frac{\partial E_{p,s,i}(z)}{\partial z} = -\frac{jc_0^2 \omega_{p,s,i}}{2n(\omega_{p,s,i})} P_{p,s,i}^{(2)}(z) e^{-j(k'_{p,s,i} - k_{p,s,i})z}$$

**Introduce phase mismatch:**  $\Delta k = k(\omega_p) - k(\omega_s) - k(\omega_i)$

**and effective nonlinearity and coupling coefficients:**

$$d_{eff} = \frac{1}{2} \chi_{ijk}^{(2)}(\omega_p : \omega_s, \omega_i), \quad \kappa_{p,s,i} = \omega_{p,s,i} d_{eff} / (n_{p,s,i} c_0)$$

## Coupled wave equations:

$$\begin{aligned}\frac{\partial E_p(z)}{\partial z} &= -j\kappa_p E_s(z)E_i(z) e^{j\Delta kz} , \\ \frac{\partial E_s(z)}{\partial z} &= -j\kappa_s E_p(z)E_i^*(z) e^{-j\Delta kz} , & \mathbf{x} \quad n_{p,s,i}c_0\epsilon_0 E_{p,s,i}^*/2 \\ \frac{\partial E_i(z)}{\partial z} &= -j\kappa_i E_p(z)E_s^*(z) e^{-j\Delta kz} .\end{aligned}$$

Intensity of waves:  $I_{p,s,i} = \frac{n_{p,s,i}}{2Z_{F0}} |E_{p,s,i}|^2$

**Manley-Rowe relations:**  $-\frac{1}{\omega_p} \frac{dI_p}{dz} = \frac{1}{\omega_s} \frac{dI_s}{dz} = \frac{1}{\omega_i} \frac{dI_i}{dz}$



## 9.4 Theory of Optical Parametric Amplification

Undepleted pump approximation:  $E_p = \text{const.}$

$$\begin{aligned}\frac{\partial E_s(z)}{\partial z} &= -j\kappa_s E_p E_i^*(z) e^{-j\Delta kz}, \\ \frac{\partial E_i(z)}{\partial z} &= -j\kappa_i E_p E_s^*(z) e^{-j\Delta kz}.\end{aligned}$$

with:

$$E_s(z=0) = E_s(0) \quad E_i(z=0) = 0$$

$$E_s(z) \sim E_s(0) e^{gz-j\Delta kz/2} \quad \text{and} \quad E_i(z) \sim E_i(0) e^{gz-j\Delta kz/2}$$

$$\longrightarrow \begin{vmatrix} g - j\frac{\Delta k}{2} & j\kappa_s E_p \\ j\kappa_i E_p^* & g + j\frac{\Delta k}{2} \end{vmatrix} = 0$$

$$g = \sqrt{\Gamma^2 - \left(\frac{\Delta k}{2}\right)^2}, \quad \text{with } \Gamma = \sqrt{\kappa_i \kappa_s |E_p|^2}.$$

gain

max. gain, when phase matched

## Maximum gain

$$\Gamma^2 = \frac{\omega_s \omega_i}{n_s n_i c_0^2} d_{eff}^2 \quad |E_p|^2 = \frac{2Z_{F0} \omega_s \omega_i}{n_p n_s n_i c_0^2} d_{eff}^2 \quad / |I_p|^2$$

$$FOM = \frac{d_{eff}}{\sqrt{\lambda_s \lambda_i n_p n_s n_i}}$$

## General solutions:

$$E_s(z) = \{E_s(0) \cosh gz + B \sinh gz\} e^{-j\Delta kz/2}$$

$$B = -j \frac{\Delta k}{2g} E_s(0) - j \frac{\kappa_1}{g} E_p E_i^*(0)$$

$$E_i(z) = \{E_i(0) \cosh gz + D \sinh gz\} e^{-j\Delta kz/2}$$

$$D = -j \frac{\Delta k}{2g} E_i(0) - j \frac{\kappa_2}{g} E_p^* E_s^*(0)$$

## Here:

$$I_s(L) = I_s(0) \left[ 1 + \frac{\Gamma^2}{g^2} \sinh^2 gL \right]$$

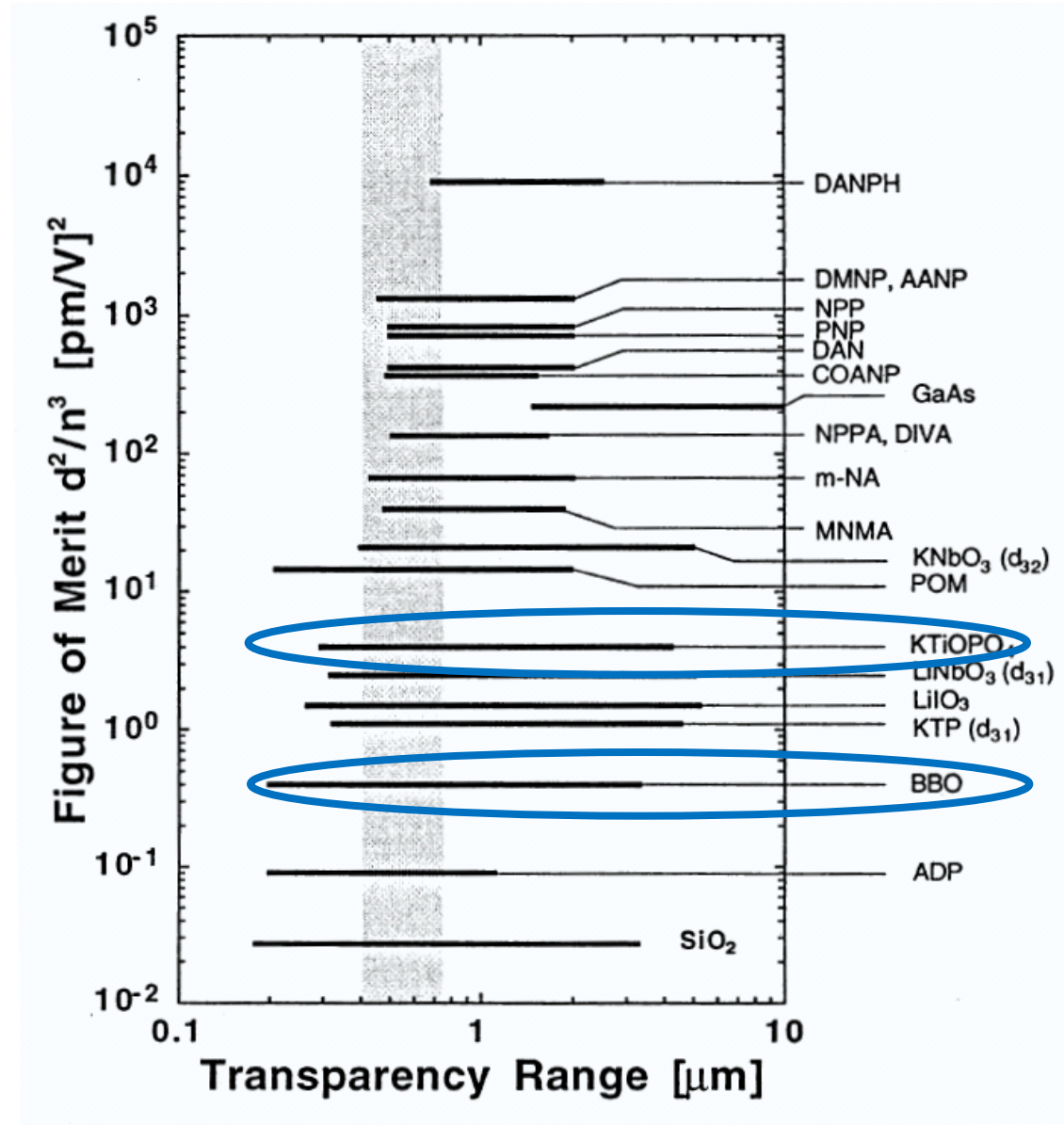
$$I_i(L) = I_s(0) \frac{\omega_i}{\omega_s} \frac{\Gamma^2}{g^2} \sinh^2 gL.$$

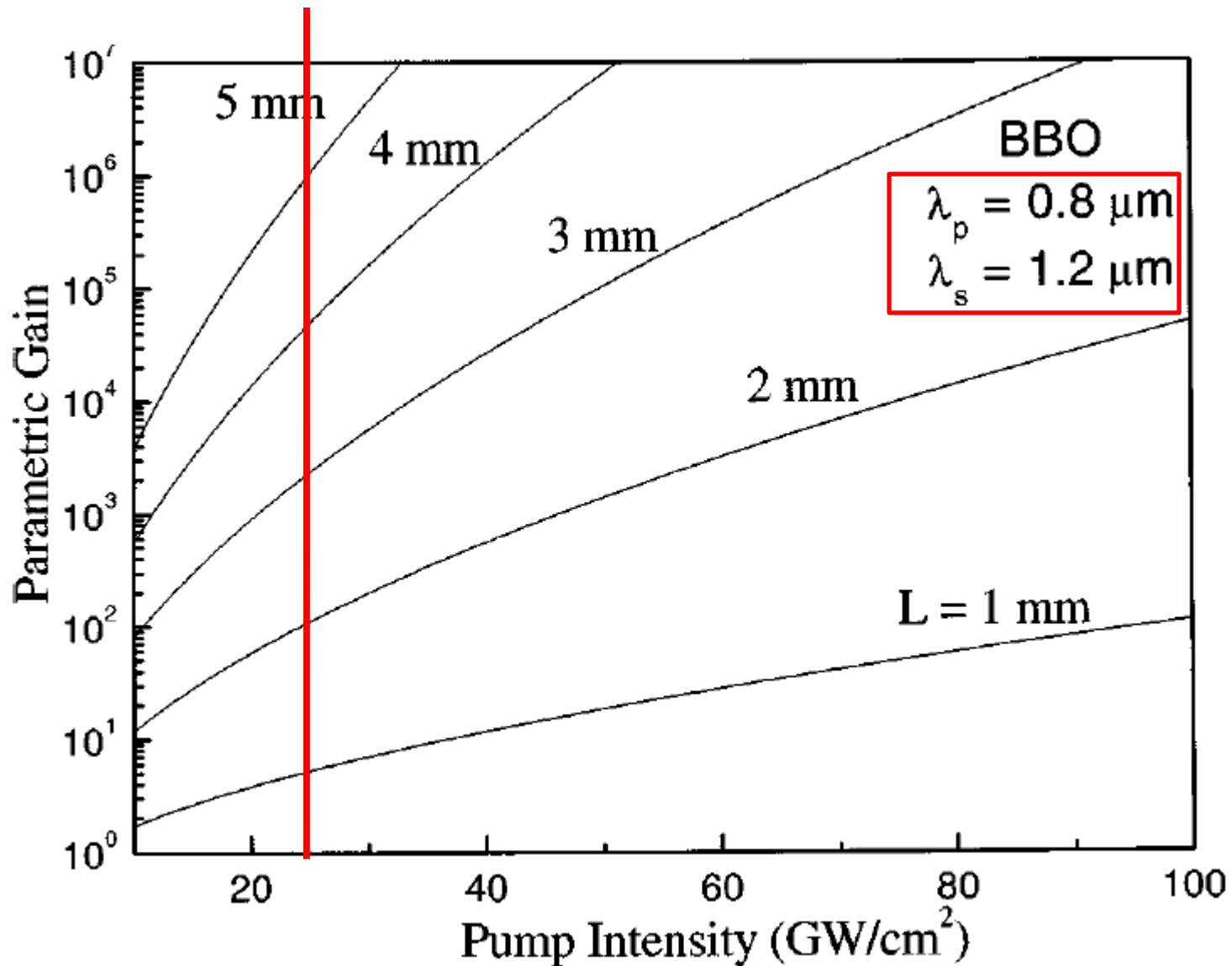
For large gain:  $\Gamma L \gg 1$

$$\begin{aligned} I_s(L) &= \frac{1}{4} I_s(0) e^{2\Gamma L}, \\ I_i(L) &= \frac{1}{4} I_s(0) \frac{\omega_i}{\omega_s} e^{2\Gamma L} \end{aligned} \quad \longrightarrow \quad G = \frac{I_s(L)}{I_s(0)} = \frac{1}{4} e^{2\Gamma L}$$

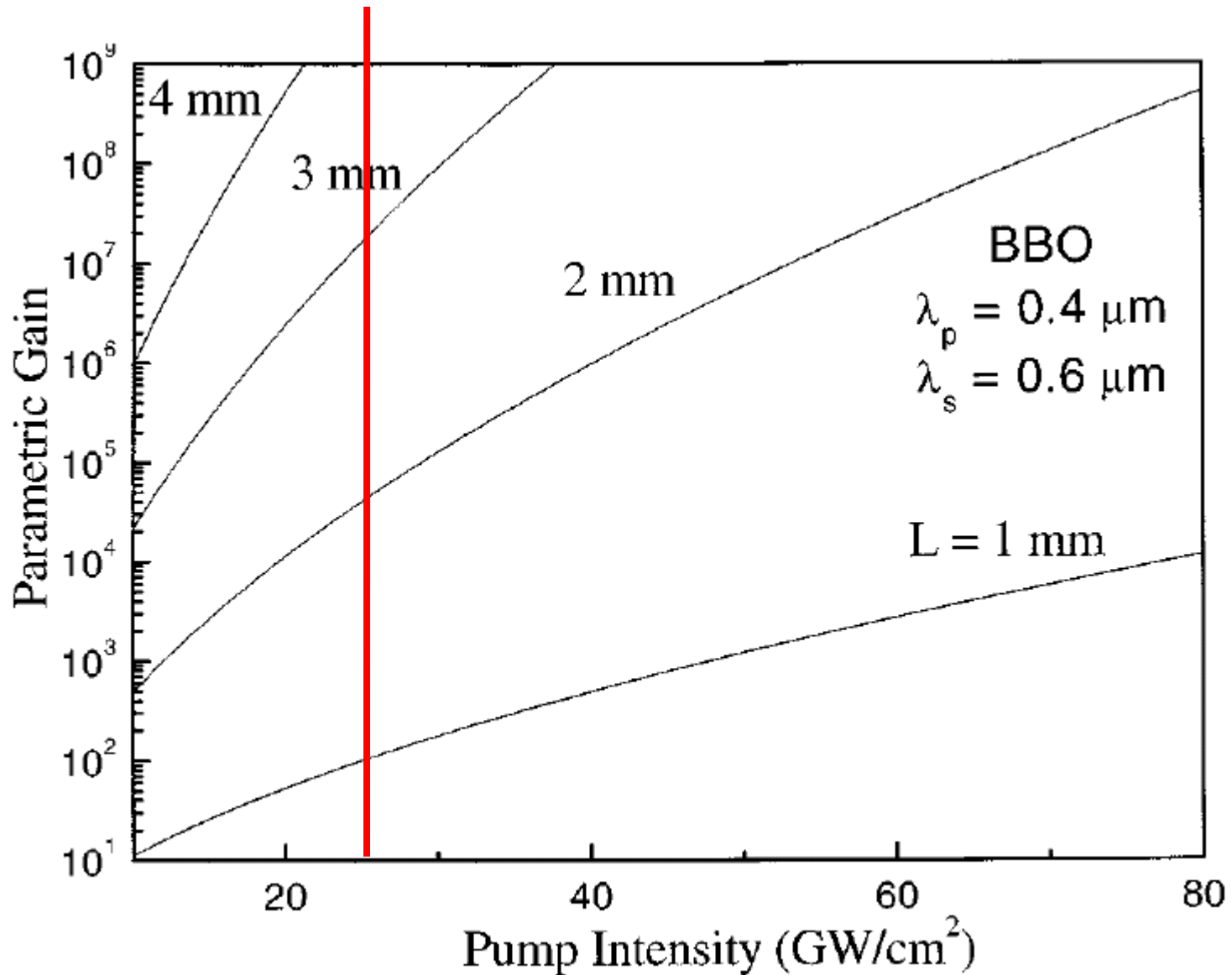
## Figure of merit:

$$FOM = \frac{d_{eff}}{\sqrt{\lambda_s \lambda_i n_p n_s n_i}}$$





**Fig. 9.3** Parametric gain for an OPA at the pump wavelength  $\lambda_p = 0.8 \mu\text{m}$  and the signal wavelength  $\lambda_s = 1.2 \mu\text{m}$ , using type-I phase matching in BBO ( $d_{\text{eff}} = 2 \text{ pm/V}$ ).



**Fig. 9.4** Parametric gain for an OPA at the pump wavelength  $\lambda_p = 0.4 \mu\text{m}$  and the signal wavelength  $\lambda_s = 0.6 \mu\text{m}$ , using type-I phase matching in BBO ( $d_{\text{eff}} = 2 \text{ pm/V}$ ).

# 9.4 Phase Matching

$$\Delta k = 0 \quad \longrightarrow \quad n_p = \frac{n_s \omega_s + n_i \omega_i}{\omega_p}$$

Uniaxial crystal:  $n_e < n_o$

**Type I: noncritical**

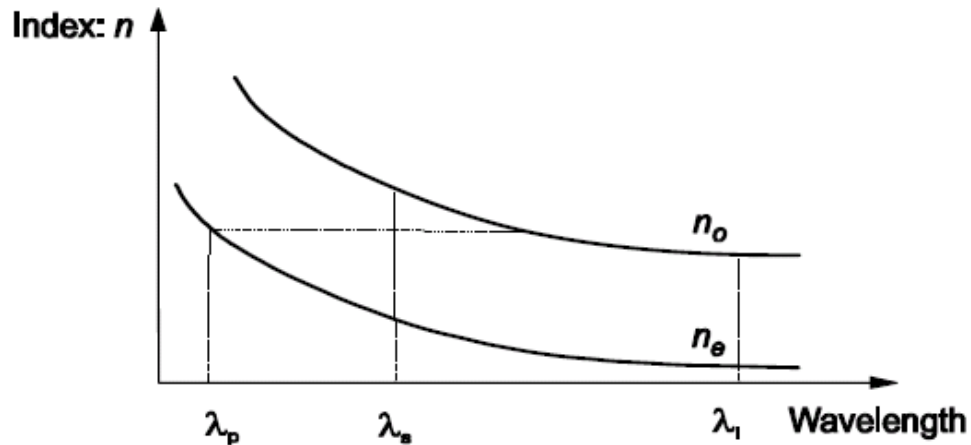


Fig. 9.5 Type-I noncritical phase matching.

**Type I: critical**

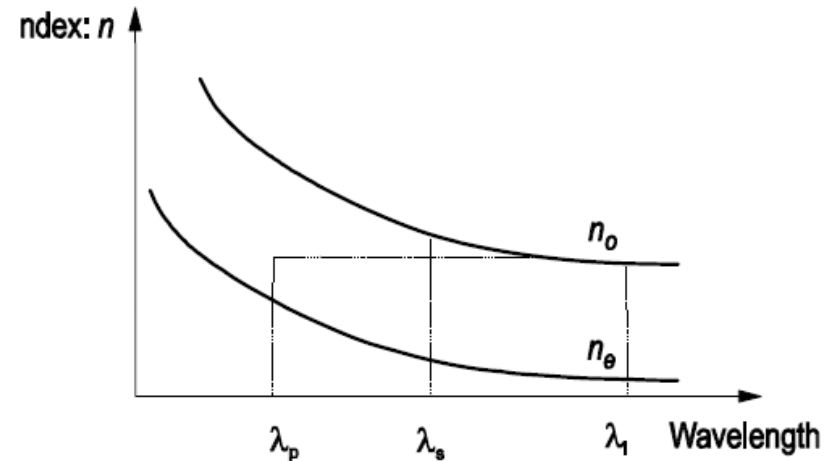
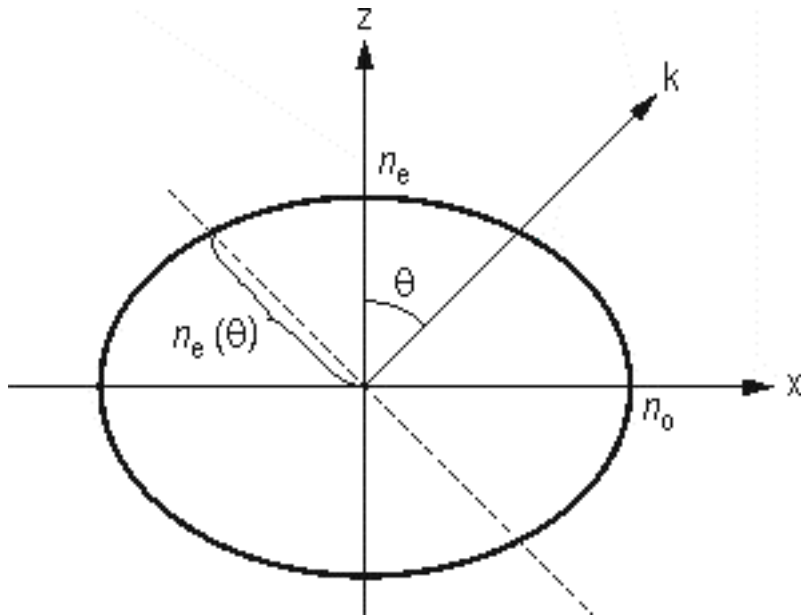


Fig. 9.6 Type-I critical phase matching by adjusting the angle  $\theta$  between wave vector of the propagating beam and the optical axis.

# 9.4 Phase Matching



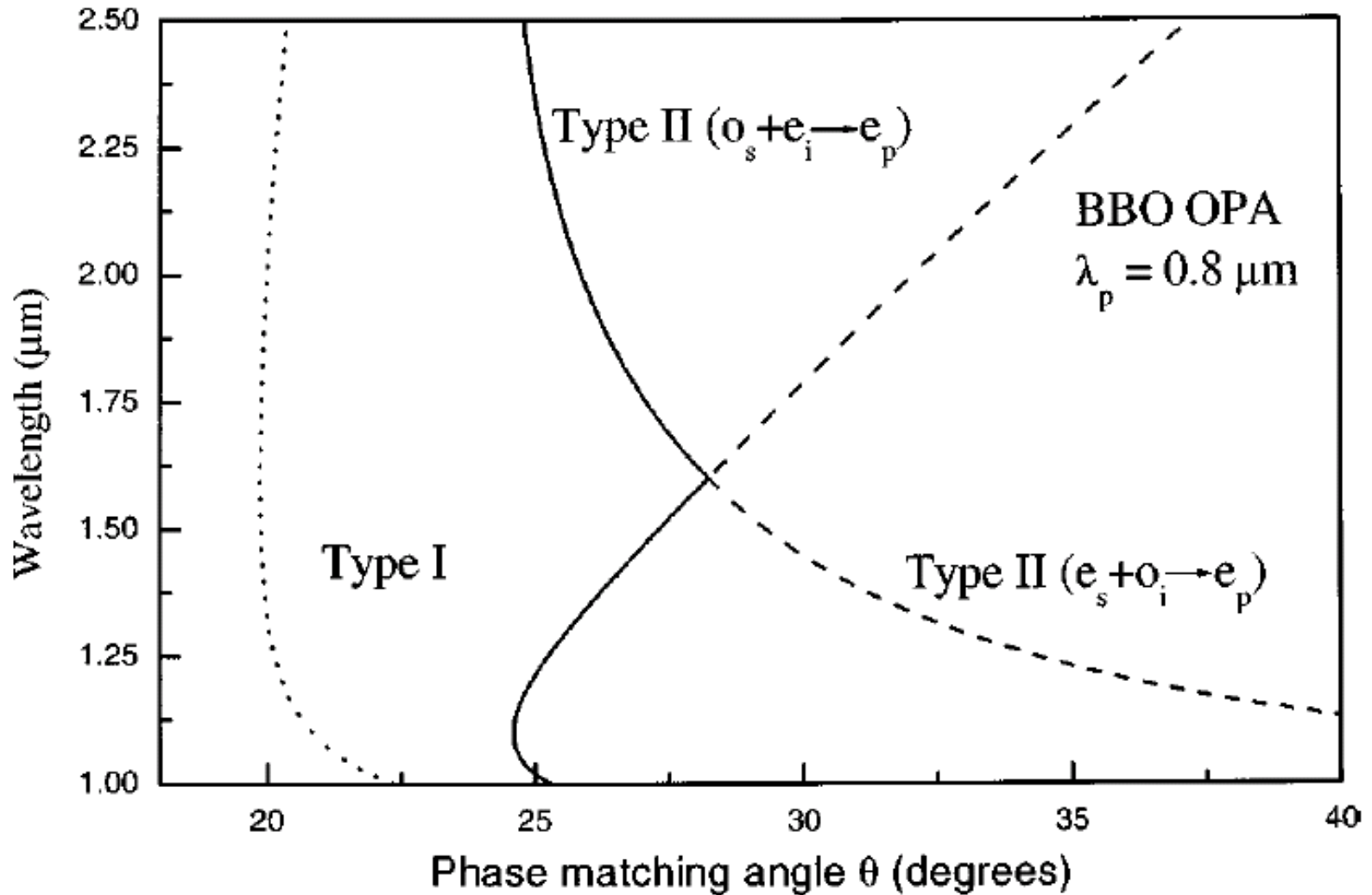
## Critical Phase Matching

$$n_{ep}(\theta)\omega_p = n_{os}\omega_s + n_{oi}\omega_i$$

$$\frac{1}{n_{ep}(\theta)^2} = \frac{\sin^2 \theta}{n_{ep}^2} + \frac{\cos^2 \theta}{n_{op}^2}$$

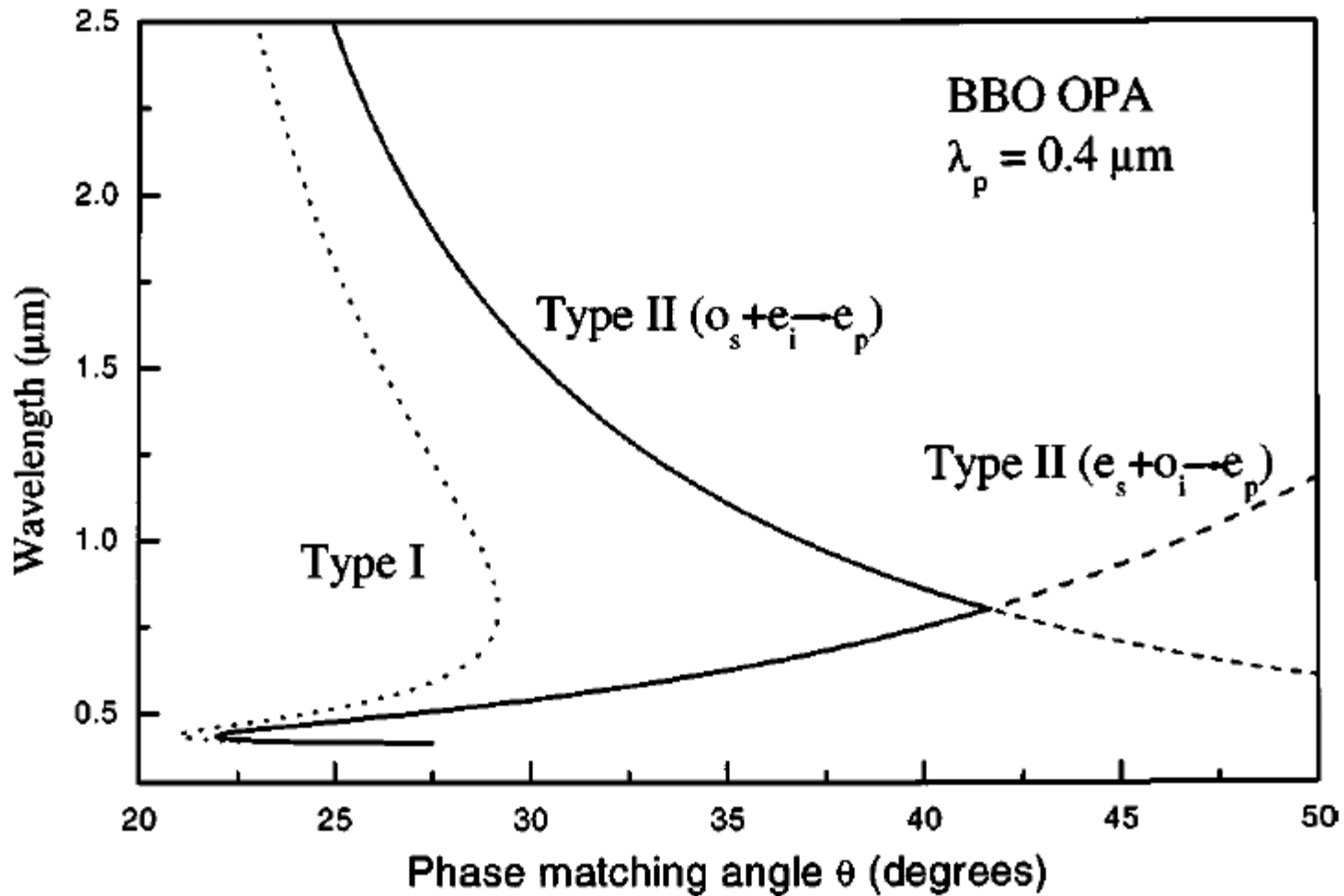
$$\theta = \arcsin \left[ \frac{n_{ep}}{n_{ep}(\theta)} \sqrt{\frac{n_{op}^2 - n_{ep}^2(\theta)}{n_{op}^2 - n_{ep}^2}} \right]$$

## 9.4 Phase Matching



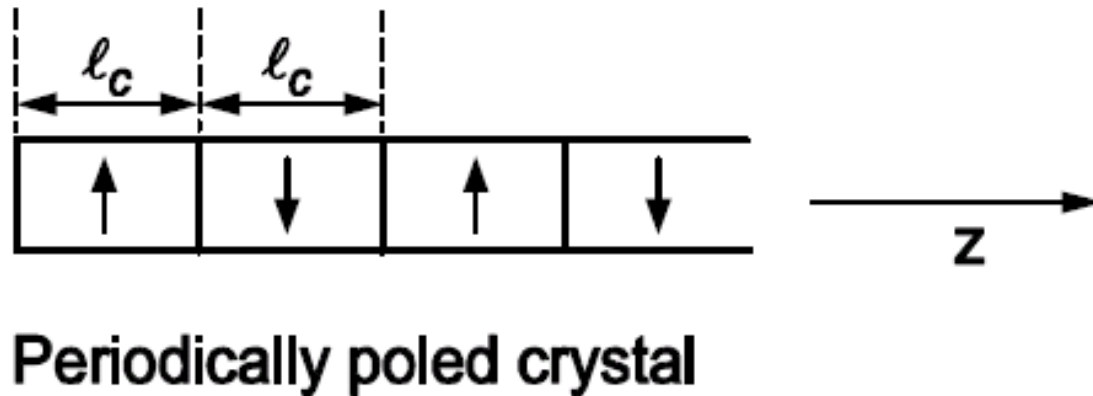
**Fig. 9.7** Angle tuning curves for a BBO OPA at the pump wavelength  $\lambda_p = 0.8 \mu\text{m}$  for type-I phase matching (dotted line), type-II ( $o_s + e_i \rightarrow e_p$ ) phase matching (solid line), and type-II ( $e_s + o_i \rightarrow e_p$ ) phase matching (dashed line).





**Fig. 9.8** Angle tuning curves for a BBO OPA at the pump wavelength  $\lambda_p = 0.4 \mu\text{m}$  for type-I phase matching (dotted line), type-II ( $o_s + e_i \rightarrow e_p$ ) phase matching (solid line), and type-II ( $e_s + o_i \rightarrow e_p$ ) phase matching (dashed line).

## 9.5 Quasi Phase Matching



**Fig.12.30:** Variation of  $d_{\text{eff}}$  in a quasi phase matched material as a function of propagation distance.

$$d_{\text{eff}}(z) = \sum_{m=-\infty}^{+\infty} d_m e^{jm\kappa z}$$

↓

$$\frac{\partial E_p(z)}{\partial z} = -j\kappa_p E_s(z)E_i(z) e^{j\Delta k z}$$

## 9.6 Ultrashort-Pulse Optical Parametric Amplification

$$\vec{E}_{p,s,i}(z, t) = \text{Re} \left\{ E_{p,s,i}(z, t) e^{j(\omega_{p,s,i}t - k_{p,s,i}z)} \vec{e}_{p,s,i} \right\}$$

Pulse envelopes

$$\begin{aligned} \frac{\partial E_p}{\partial z} + \frac{1}{v_p} \frac{\partial E_p}{\partial t} &= -j\kappa_p E_s E_i e^{j\Delta kz} , \\ \frac{\partial E_s}{\partial z} + \frac{1}{v_s} \frac{\partial E_s}{\partial t} &= -j\kappa_s E_p E_i^* e^{-j\Delta kz} , \\ \frac{\partial E_i}{\partial z} + \frac{1}{v_i} \frac{\partial E_s}{\partial t} &= -j\kappa_i E_p E_s^* e^{-j\Delta kz} , \end{aligned}$$

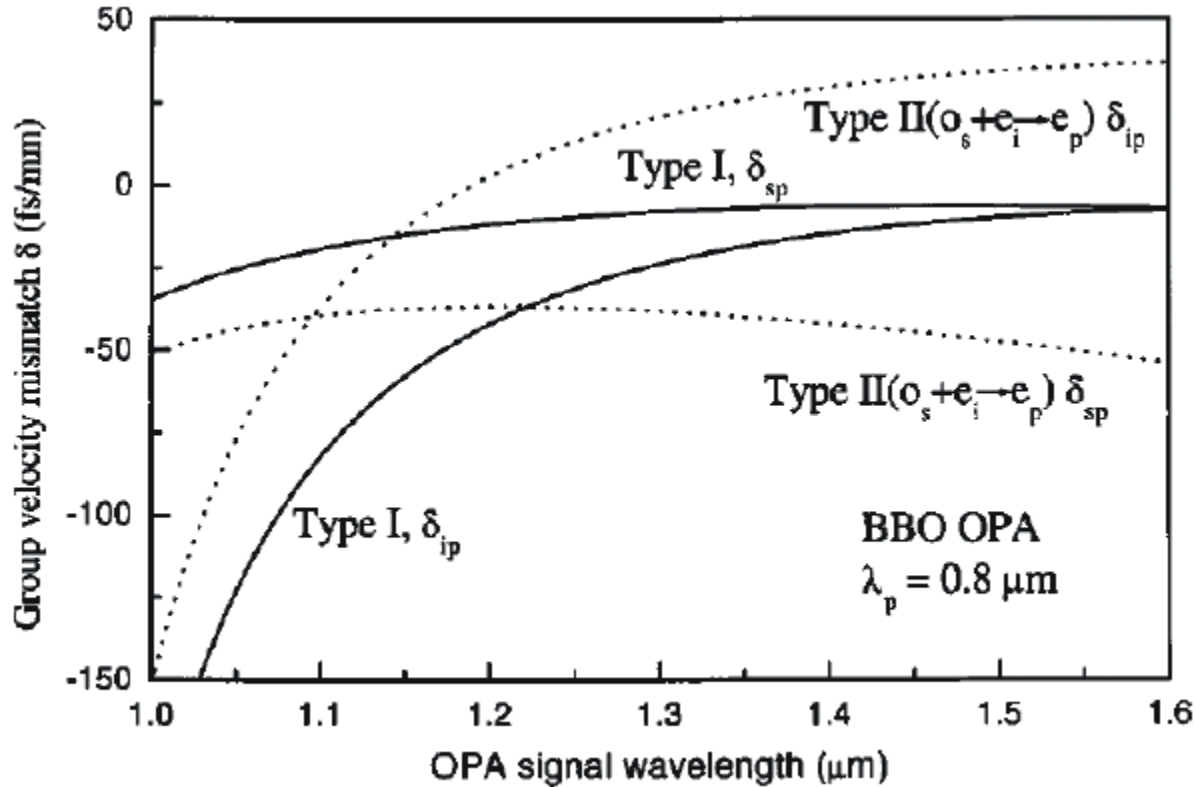
$v_{p,s,i} = dk/d\omega|_{\omega_{p,s,i}}$  are the corresponding group velocities

$$\begin{aligned} t' = t - z/v_p \quad \frac{\partial E_p}{\partial z} &= -j\kappa_p E_s E_i e^{j\Delta kz} , \\ \frac{\partial E_s}{\partial z} + \left( \frac{1}{v_s} - \frac{1}{v_p} \right) \frac{\partial E_s}{\partial t} &= -j\kappa_s E_p E_i^* e^{-j\Delta kz} , \\ \frac{\partial E_i}{\partial z} + \left( \frac{1}{v_i} - \frac{1}{v_p} \right) \frac{\partial E_s}{\partial t} &= -j\kappa_i E_p E_s^* e^{-j\Delta kz} . \end{aligned}$$

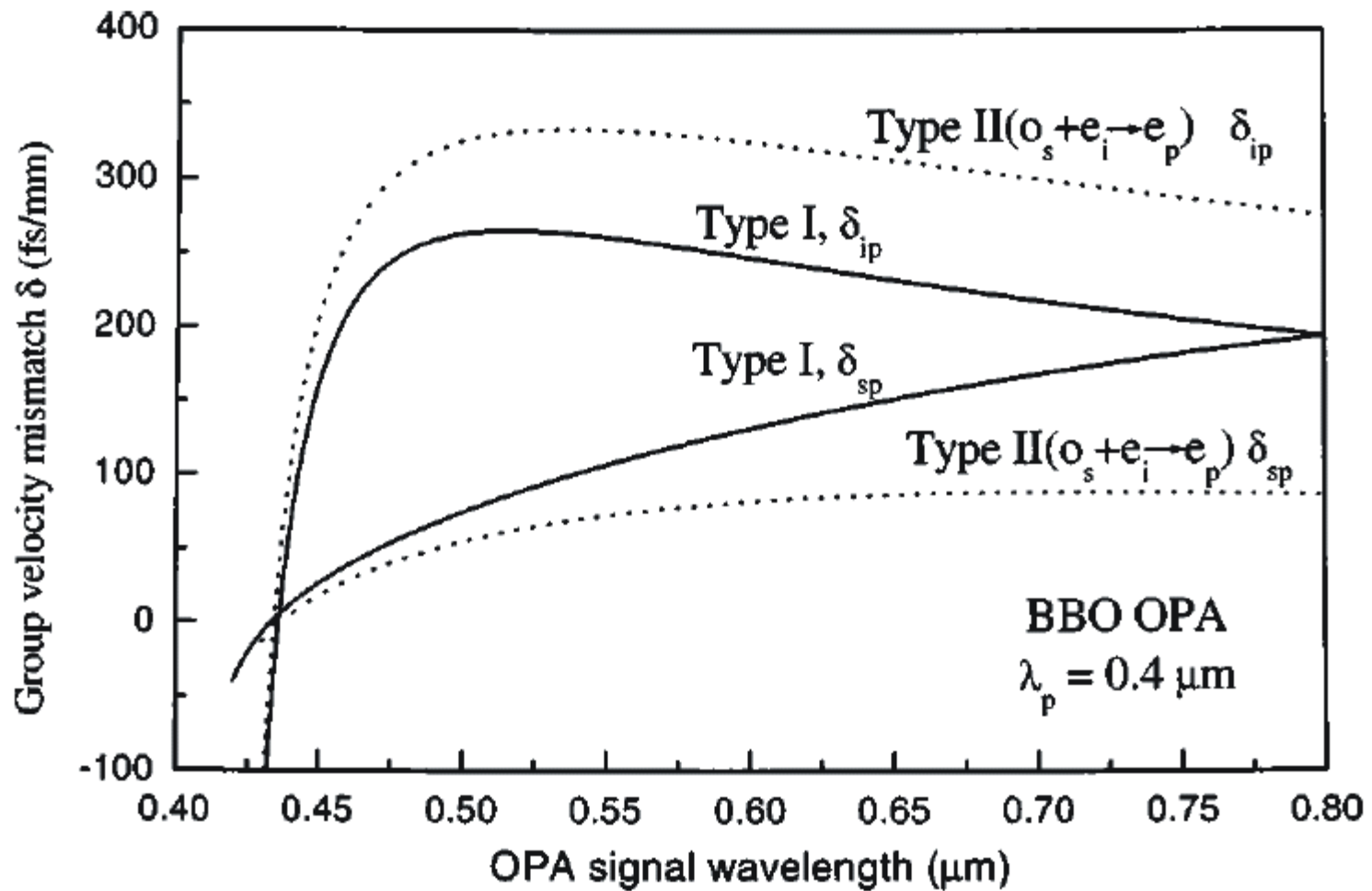
**Temporal walkoff**  
**Group Velocity Mismatch (GVM)**

**Pump pulse width**

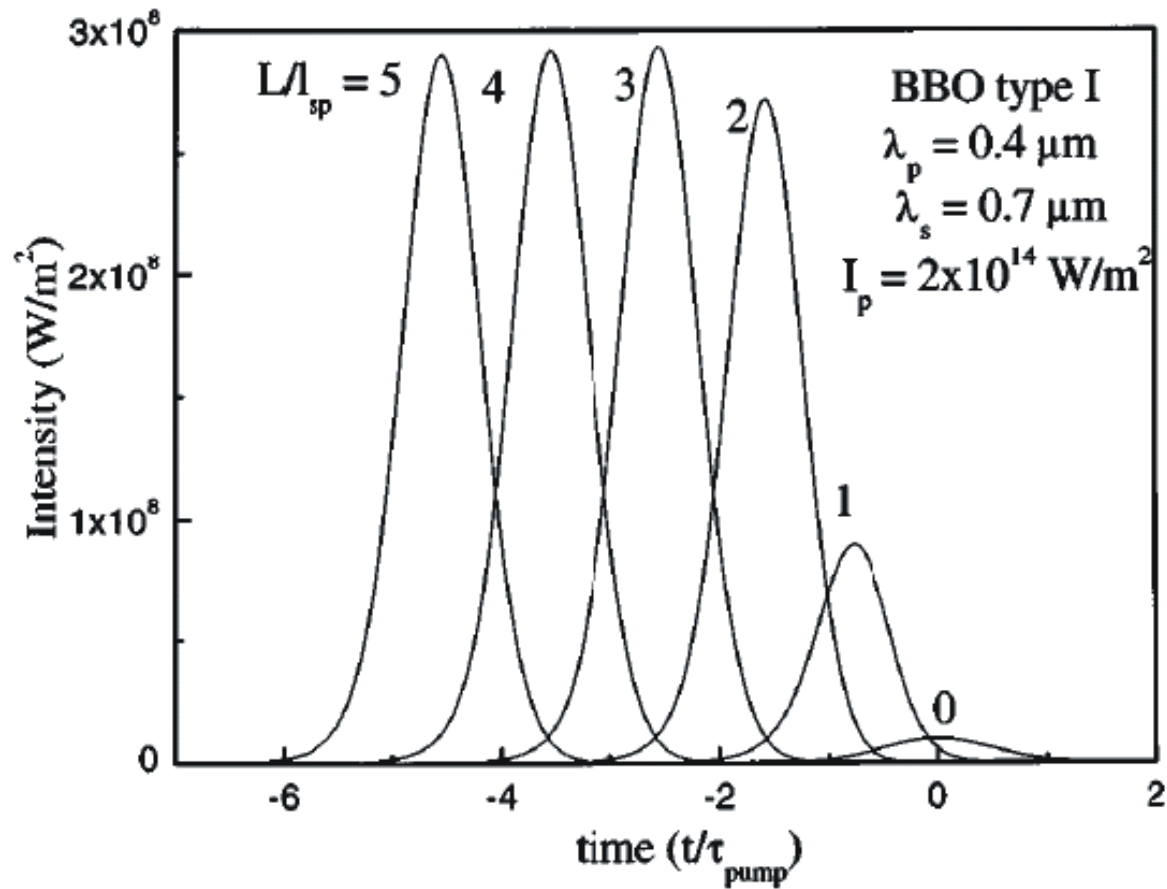
$$l_{jp} = \frac{\tau}{\delta_{jp}}, \text{ with } \delta_{jp} = \left( \frac{1}{v_j} - \frac{1}{v_p} \right) \quad j=s,i$$



**Fig. 9.9:** Pump-signal ( $\delta_{sp}$ ) and pump-idler ( $\delta_{ip}$ ) group velocity mismatch curves for a BBO OPA at the pump wavelength  $\lambda_p = 0.8 \mu\text{m}$  for type-I phase matching (solid line) and type-II ( $o_s + e_i \rightarrow e_p$ ) phase matching (dashed line).



**Fig. 9.10:** Pump-signal ( $\delta_{sp}$ ) and pump-idler ( $\delta_{ip}$ ) group velocity mismatch curves for a BBO OPA at the pump wavelength  $\lambda_p = 0.4 \mu\text{m}$  for type-I phase matching (solid line) and type-II ( $o_s + e_i \rightarrow e_p$ ) phase matching (dashed line).



**Fig. 9.11:** Signal pulse evolution for a BBO type-I OPA with  $\lambda_p = 0.4 \mu\text{m}$ ,  $\lambda_s = 0.7 \mu\text{m}$ , for different lengths  $L$  of the nonlinear crystal. Pump intensity is  $20 \text{ GW/cm}^2$ . Time is normalized to the pump pulse duration and the crystal length to the pump-signal pulse splitting length. [5]

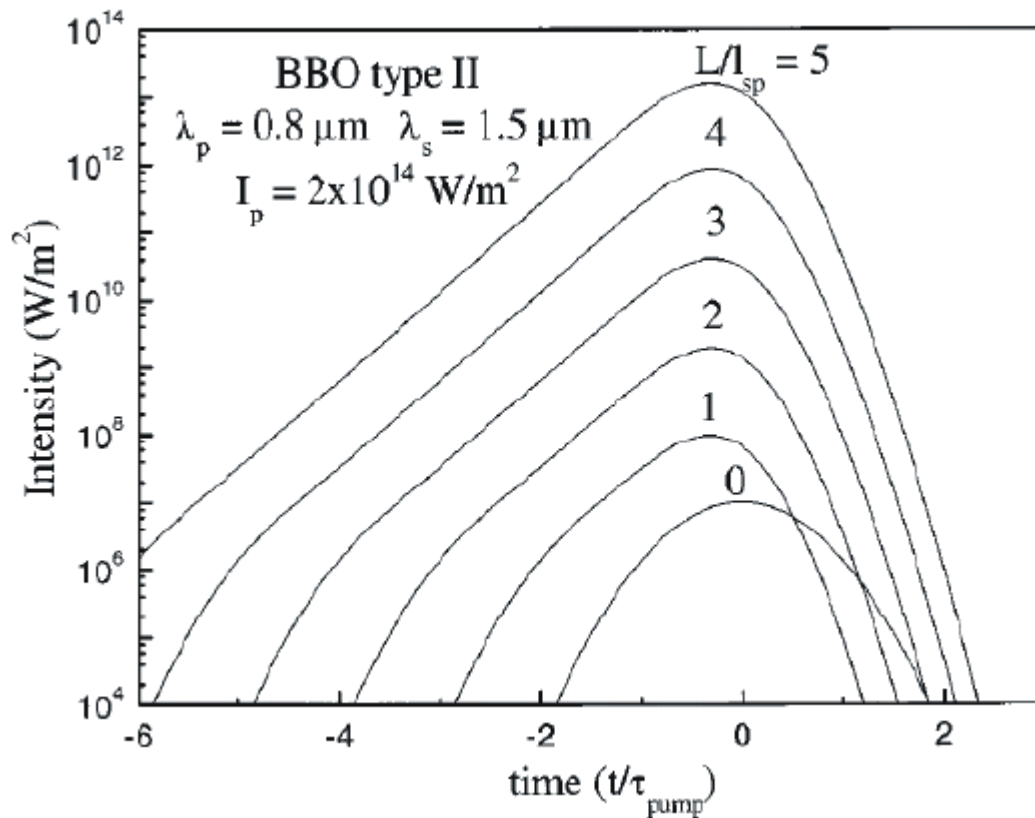


Figure 9.12: Signal pulse evolution for a BBO type-II OPA with  $\lambda_p = 0.8 \mu\text{m}$ ,  $\lambda_s = 1.5 \mu\text{m}$ , for different lengths  $L$  of the nonlinear crystal. Pump intensity is  $20 \text{ GW/cm}^2$ . Time is normalized to the pump pulse duration and the crystal length to the pump-signal pulse splitting length. [5]

# OPA Bandwidth

$$\omega_s \longrightarrow \omega_s + \Delta\omega \quad \omega_i \longrightarrow \omega_i - \Delta\omega.$$

$$\Delta k = -\frac{dk_s}{d\omega} \Delta\omega + \frac{dk_i}{d\omega} \Delta\omega = \left( \frac{1}{v_i} - \frac{1}{v_s} \right) \Delta\omega$$

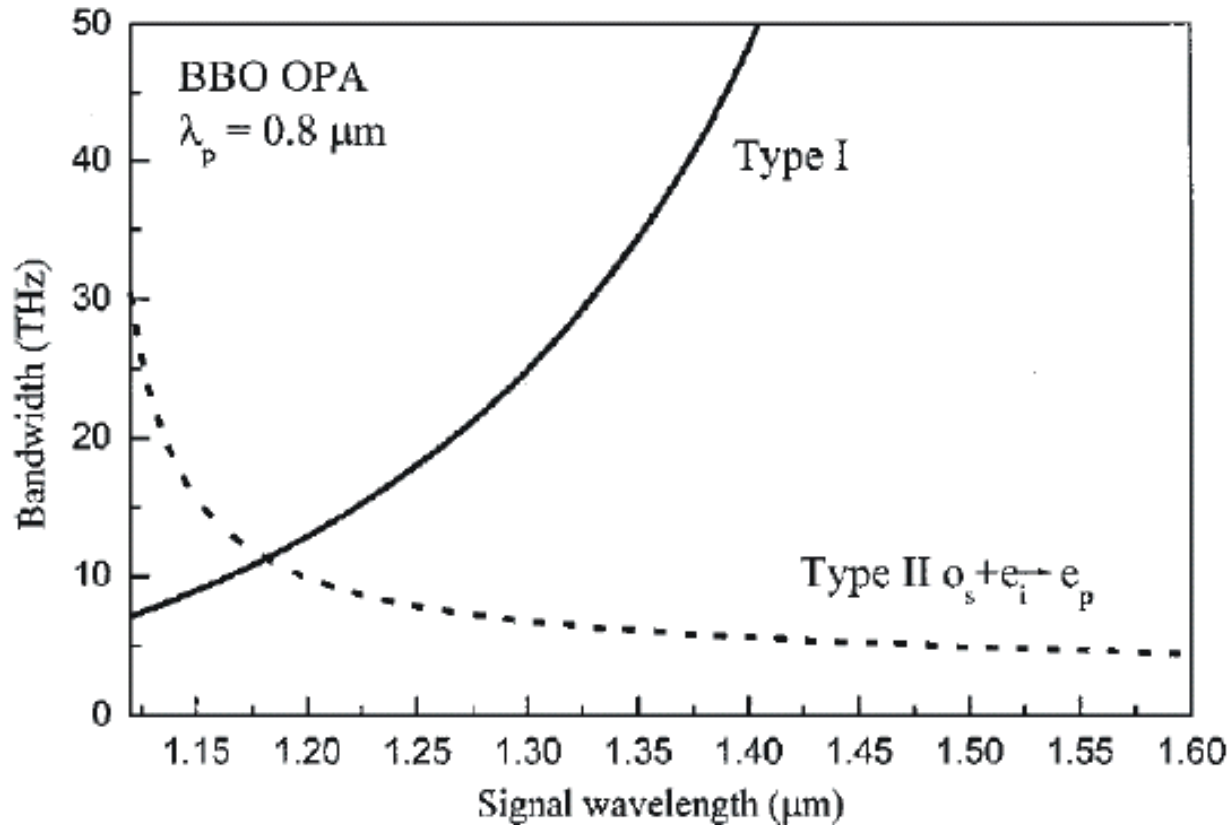
## Bandwidth limitation due to GVM

$$\Delta f = -\frac{2\sqrt{\ln 2}}{\pi} \sqrt{\frac{\Gamma}{L}} \frac{1}{\left| \frac{1}{v_i} - \frac{1}{v_s} \right|}$$

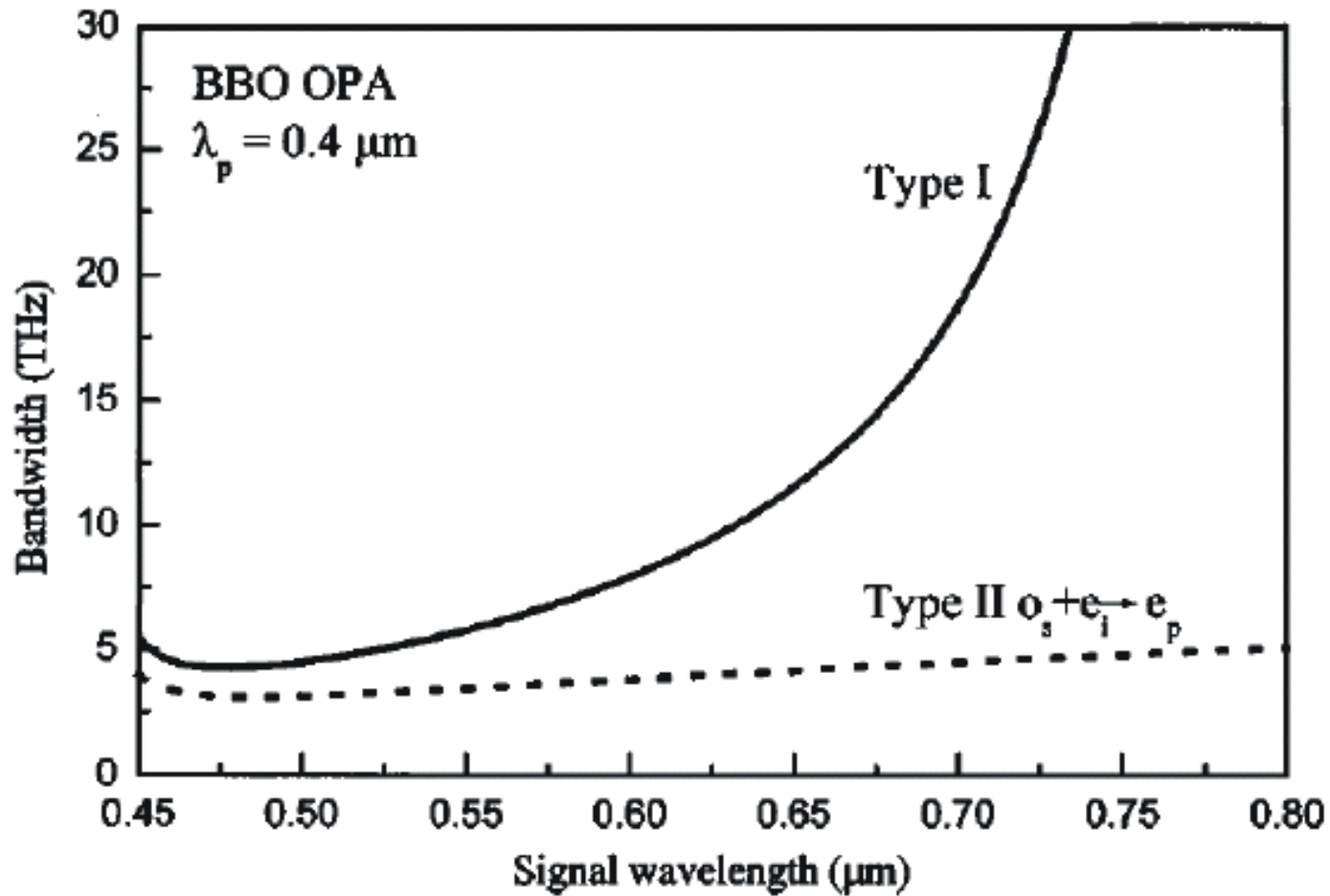
For signal-idler group velocity matching:

$$\Delta f = -\frac{2\sqrt[4]{\ln 2}}{\pi} \sqrt[4]{\frac{\Gamma}{L}} \frac{1}{\left| \frac{d^2 k_s}{d\omega^2} + \frac{d^2 k_i}{d\omega^2} \right|}$$



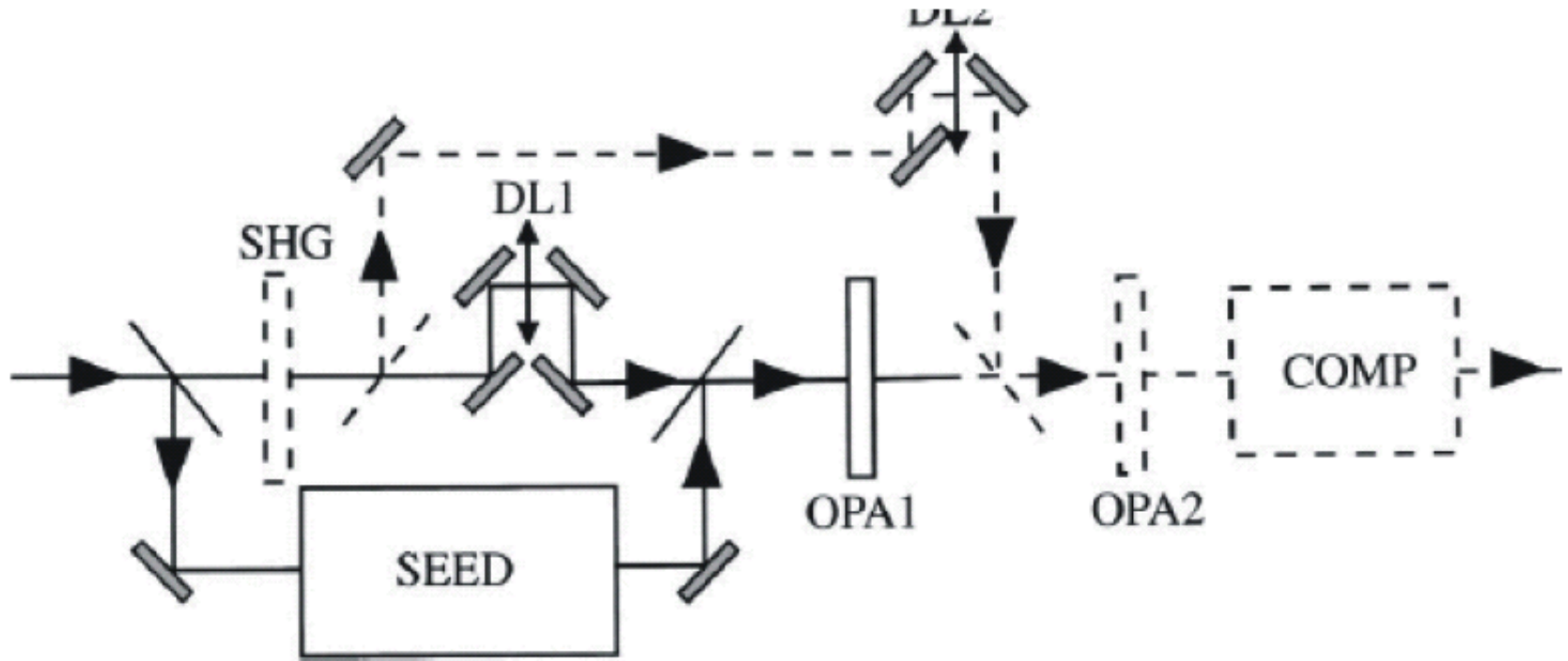


**Fig. 9.13:** Phase matching bandwidth for a BBO OPA at the pump wavelength  $\lambda_p=0.8 \mu\text{m}$  for type-I phase matching (solid line) and type-II ( $o_s + e_i \rightarrow e_p$ ) phase matching (dashed line). Crystal length is 4 mm and pump intensity 50 GW/cm<sup>2</sup>.



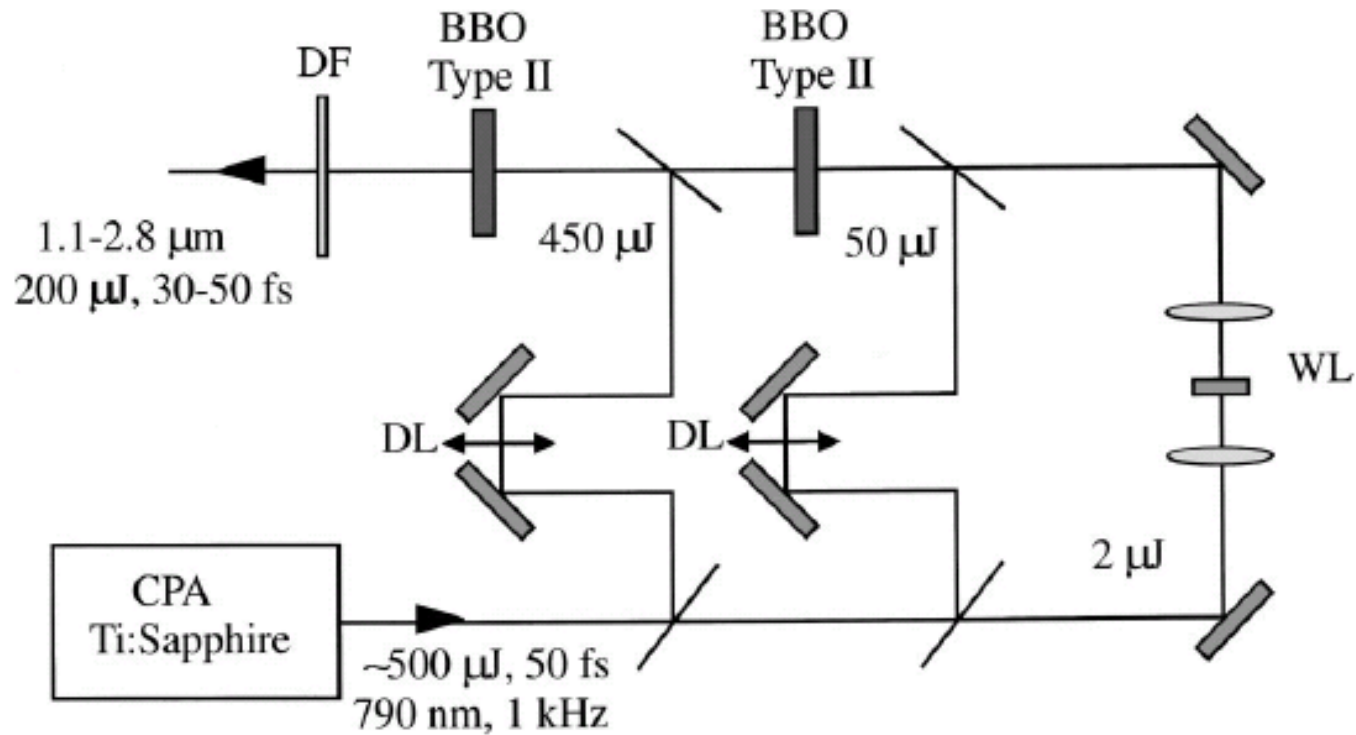
**Fig. 9.14:** Phase matching bandwidth for a BBO OPA at the pump wavelength  $\lambda_p=0.4 \mu\text{m}$  for type-I phase matching (solid line) and type-II ( $o_s + e_i \rightarrow e_p$ ) phase matching (dashed line). Crystal length is 2 mm and pump intensity  $100 \text{ GW/cm}^2$ .

## 9.7 Optical Parametric Amplifier Designs



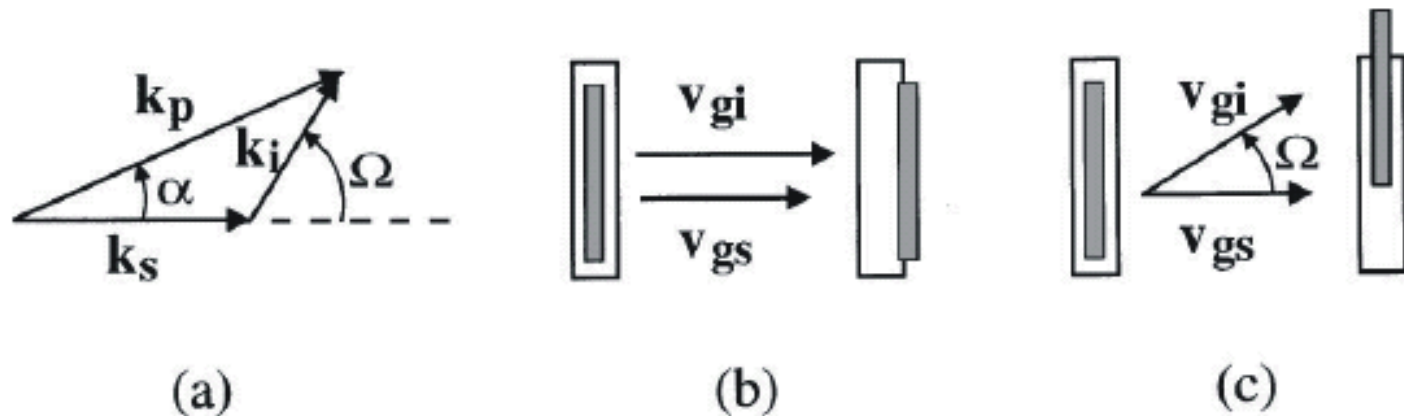
**Fig. 9.15:** Scheme of an ultrafast optical parametric amplifier. SEED: seed generation stage; DL1, DL2: delay lines; OPA1, OPA2 parametric amplification stages; COMP: compressor.

## Near-IR OPA



**Fig. 9.16:** Scheme of a near-IR OPA. DL: delay lines; WL: white light generation stage; DF: dichroic filter. [5]

## 9.8 Noncollinear Optical Parametric Amplifier (NOPA)



**Fig. 9.17:** a) Schematic of a noncollinear interaction geometry; b) representation of signal and idler pulses in the case of collinear interaction; and c) same as b) for noncollinear interaction.

**Phase-matching condition: vector condition:**

$$\begin{aligned} \Delta k_{par} &= k_p \cos \alpha - k_s - k_i \cos \Omega = 0 \\ \Delta k_{perp} &= k_p \sin \alpha - k_i \sin \Omega = 0 \end{aligned}$$

## Variation on phase matching condition by $\Delta\omega$

$$\Delta k_{par} = -\frac{dk_s}{d\omega_s}\Delta\omega + \frac{dk_i}{d\omega_i}\cos\Omega\Delta\omega - k_i\sin\Omega\frac{d\Omega}{d\omega_i}\Delta\omega = 0 \quad \times \cos(\Omega)$$

$$\Delta k_{perp} = \frac{dk_i}{d\omega_i}\sin\Omega\Delta\omega + k_i\cos\Omega\frac{d\Omega}{d\omega_i}\Delta\omega = 0 \quad \times \sin(\Omega)$$

and addition

$$\frac{dk_i}{d\omega_i} - \cos\Omega\frac{dk_s}{d\omega_s} = 0$$

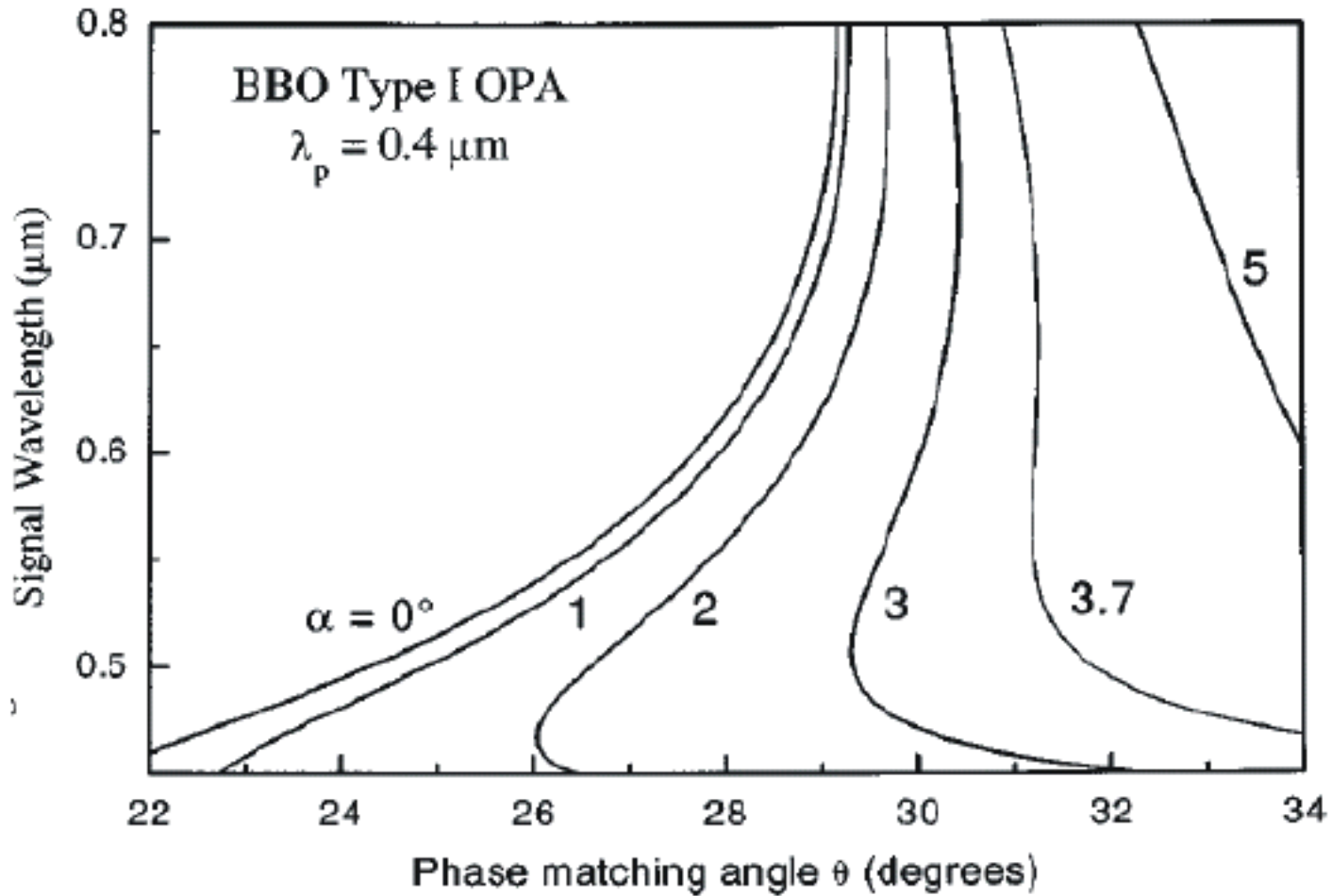
Correct  
index

$$v_{gs} - v_{gi} \cos\Omega = 0$$

Only possible if:

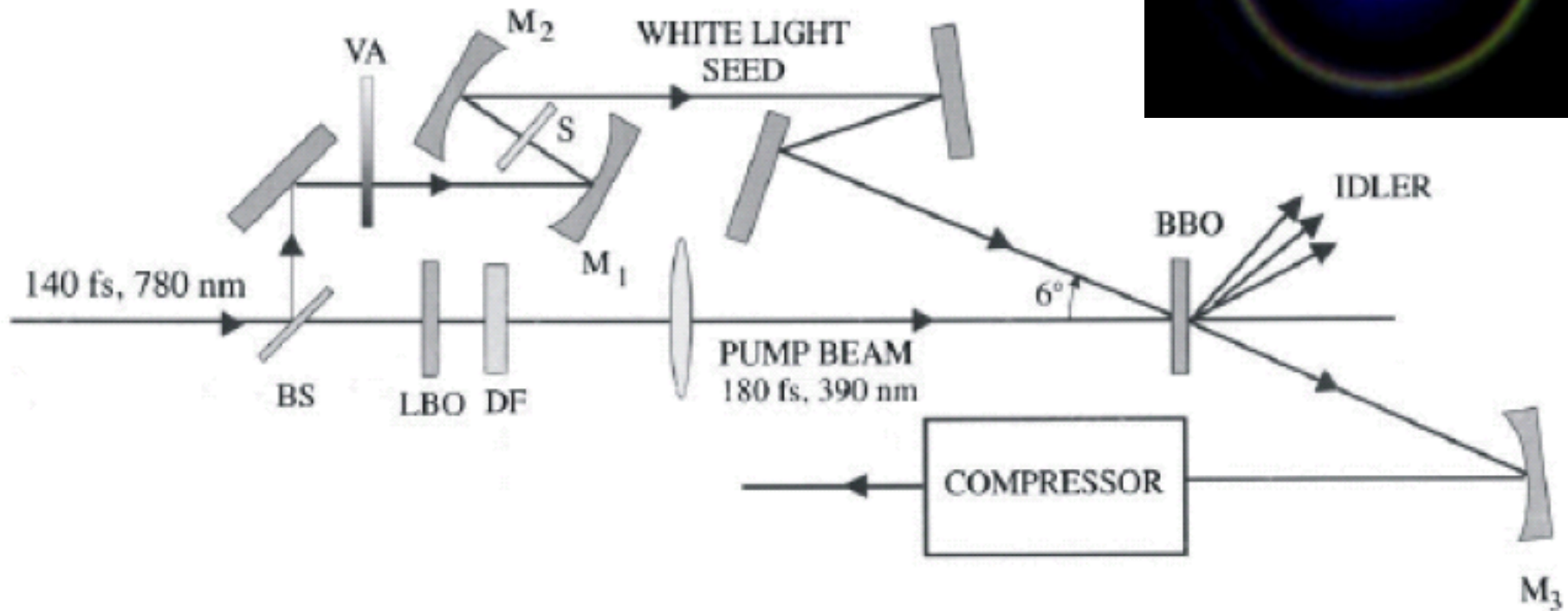
$$v_{gi} > v_{gs}$$

$$\alpha = \arcsin \left[ \frac{1 - \frac{v_s^2}{v_i^2}}{1 + 2v_s n_s \lambda_i / v_i n_i \lambda_s + (n_s \lambda_i / n_i \lambda_s)^2} \right]$$



**Fig. 9.18:** Phase-matching curves for a noncollinear type-I BBO OPA pumped at  $\lambda_p=0.4 \mu\text{m}$ , as function of the pump-signal angle  $\alpha$ . [5]

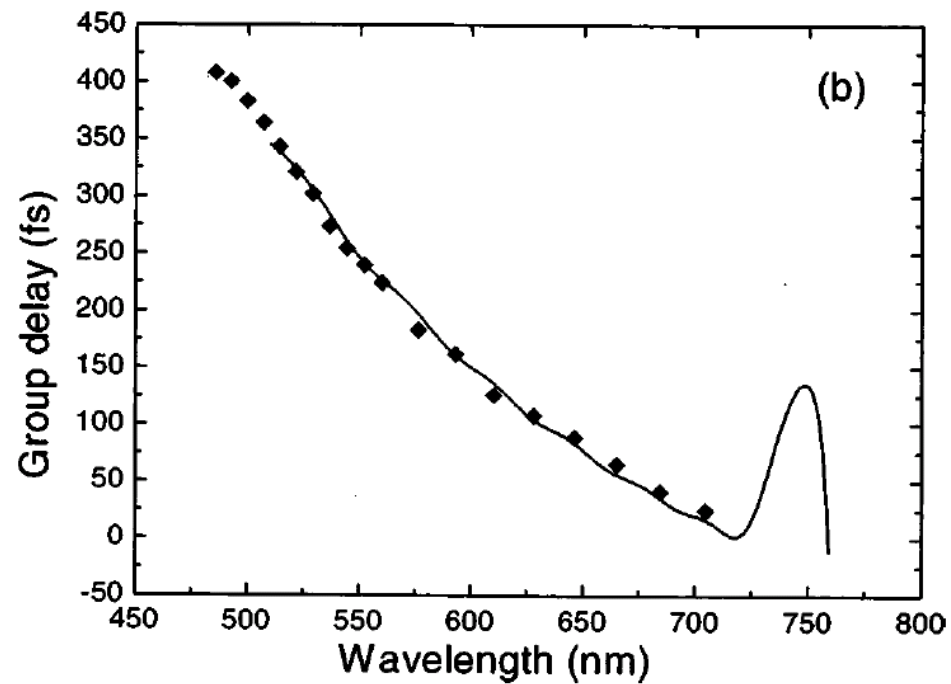
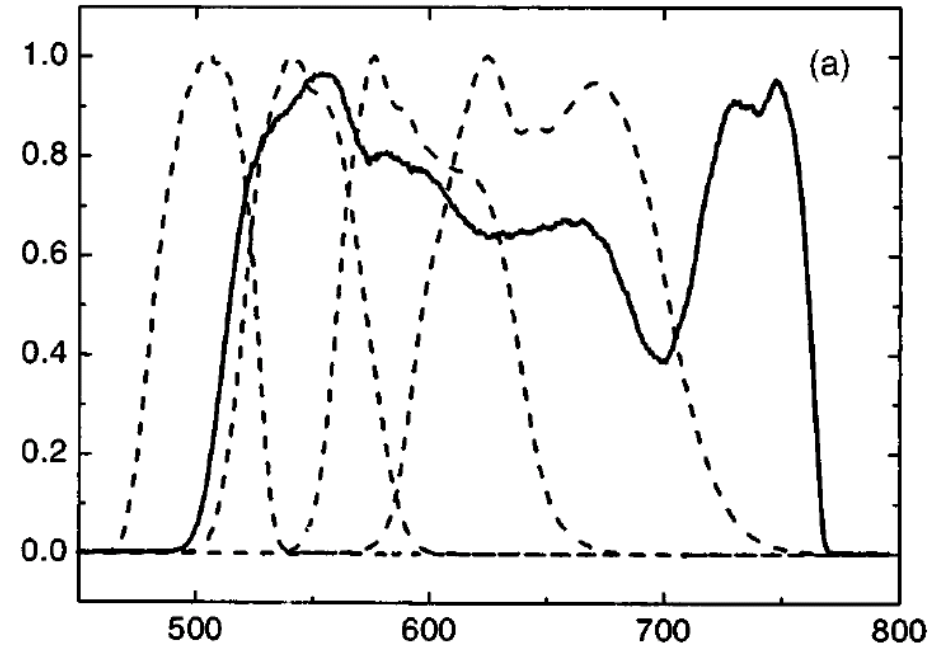
# NOPA Layout

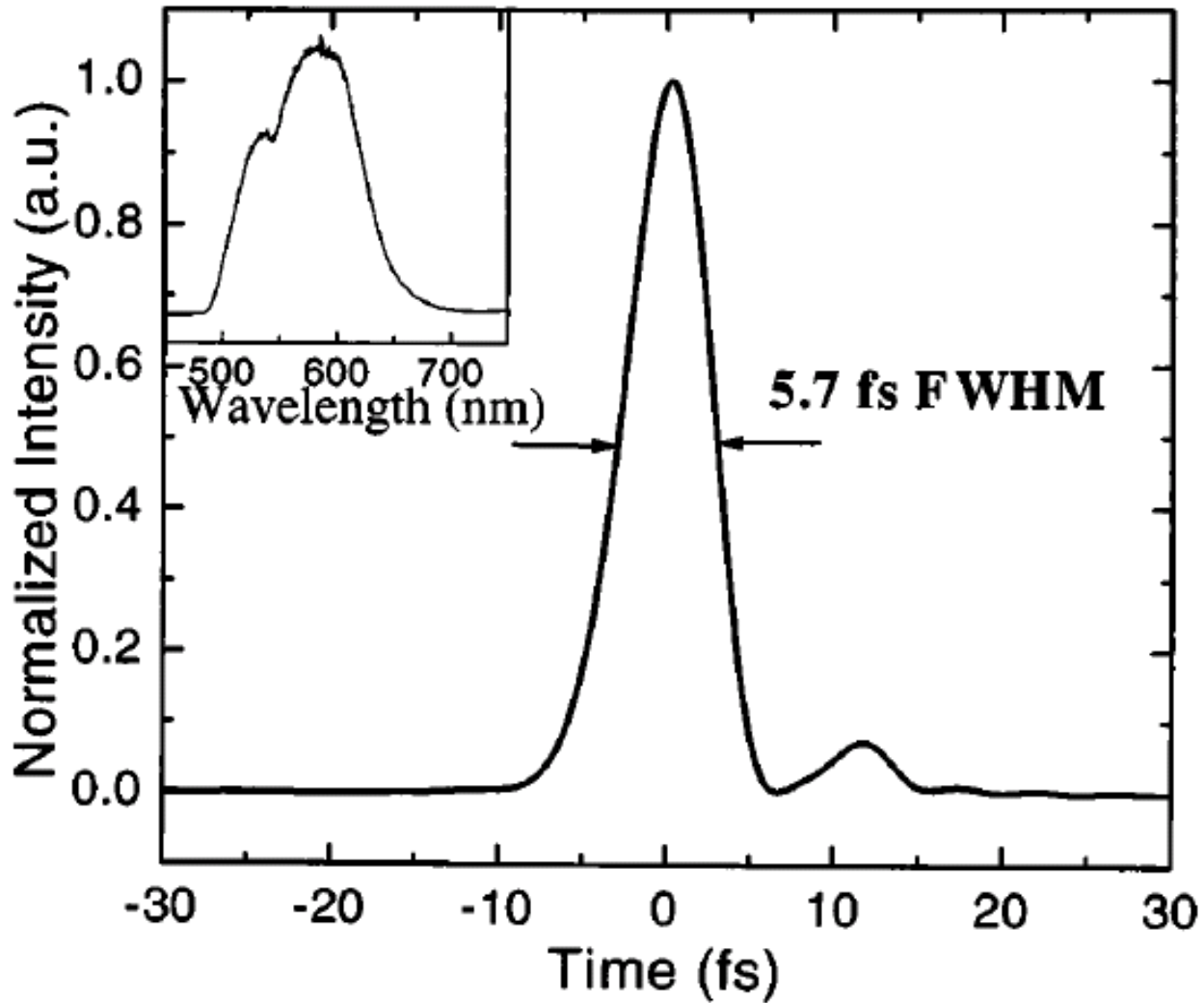


**Fig. 9.19:** Scheme of a noncollinear visible OPA. BS: beam splitter; VA: variable attenuator; S: 1-mm-thick sapphire plate; DF: dichroic filter; M<sub>1</sub>, M<sub>2</sub>, M<sub>3</sub>, spherical mirrors. [5]



**Fig. 9.20:** a) Solid line: NOPA spectrum under optimum alignment conditions; dashed line: sequence of spectra obtained by increasing the white light chirp; b) points: measured group delay (GD) of the NOPA pulses; dashed line: GD after ten bounces on the ultrabroadband chirped mirrors.





**Fig. 9.21:** Reconstructed temporal intensity of the compressed NOPA pulse measured by the SPIDER technique. The inset shows the corresponding pulse spectrum. [5]

# 9.9 Optical Parametric Chirped-Pulse Amplifier (OPCPA)

## 2- $\mu\text{m}$ OPCPA

